

User Manual

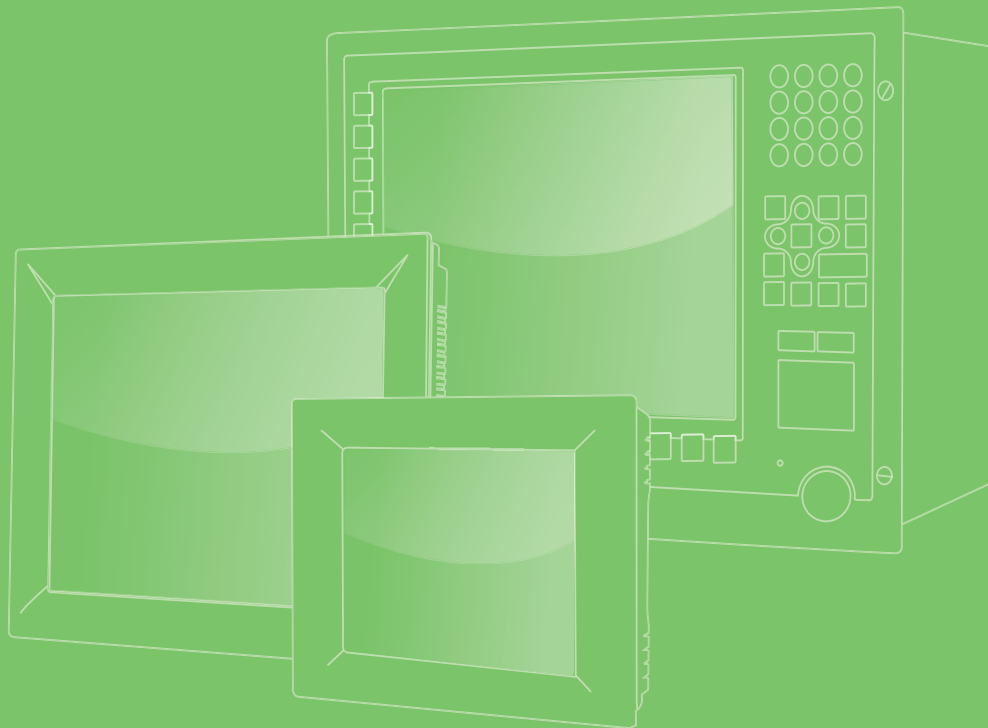

## TPC-100W Series

電腦

7"/10.1"/15.6"/21.5" Touch Panel  
Computer with  
ARM<sup>®</sup> Cortex<sup>®</sup>-A53 Processor

**ADVANTECH**

*Enabling an Intelligent Planet*

**限用物質含有情況標示聲明書**  
**Declaration of the Presence Condition of the Restricted Substances Marking**

設備名稱：電腦 Equipment name		型號（型式）：TPC-107W、TPC-115W、TPC-110W Type designation (Type)				
單元 Unit	限用物質及其化學符號 Restricted substances and their chemical symbols					
	鉛 Lead (Pb)	汞 Mercury (Hg)	鎘 Cadmium (Cd)	六價鉻 Hexavalent chromium (Cr <sup>+6</sup> )	多溴聯苯 Polybrominated biphenyls (PBB)	多溴二苯醚 Polybrominated diphenyl ethers (PBDE)
電路板	-	○	○	○	○	○
內外殼（外殼、內部 框架…等）	-	○	○	○	○	○
其它固定組件（螺 絲、夾具、卡榫）	-	○	○	○	○	○
配件（滑鼠、鍵盤、 電源線、排線、傳輸 線、網路線…等）	○	○	○	○	○	○
液晶面板	-	○	○	○	○	○
觸控模組	-	○	○	○	○	○
備考 1. “超出 0.1 wt %” 及 “超出 0.01 wt %” 係指限用物質之百分比含量超出百分比含量基準值。 Note 1. “Exceeding 0.1 wt %” and “exceeding 0.01 wt %” indicate that the content of the restricted substance exceeds the defined concentration limit.						
備考 2. “○” 係指該項限用物質之百分比含量未超出百分比含量基準值。 Note 2. “○” indicates that the content of the restricted substance does not exceed the defined concentration limit.						
備考 3. “-” 係指該項限用物質為排除項目。 Note 3. “-” indicates that the restricted substance is not present in the product.						

製造商：研華股份有限公司  
地址：台北市內湖區瑞光路 26 巷 20 弄 1 號  
電話：02-27927818

Manufacturer: ADVANTECH Co., Ltd.  
Address: No. 1 Alley 20 Lane 26, Rueiguang Rd., Neihu District, Taipei City  
Telephone: 02-27927818

## Copyright

The documentation and the software included with this product are copyrighted 2023 by Advantech Co., Ltd. All rights are reserved. Advantech Co., Ltd. reserves the right to make improvements in the products described in this manual at any time without notice. No part of this manual may be reproduced, copied, translated, or transmitted in any form or by any means without the prior written permission of Advantech Co., Ltd. The information provided in this manual is intended to be accurate and reliable. However, Advantech Co., Ltd. assumes no responsibility for its use, nor for any infringements of the rights of third parties that may result from its use.

## Acknowledgments

NXP and Freescale are registered trademarks of NXP Semiconductors N.V.  
All other product names or trademarks are properties of their respective owners.

This manual is applicable to the following models:

TPC-107W

TPC-107W-N31YB

TPC-107W-N31AB

TPC107WXXXXXXXXXX-T

TPC-110W

TPC-110W-N31YB

TPC-110W-N31AB

TPC110WXXXXXXXXXX-T

TPC-115W

TPC-115W-N31YB

TPC-115W-N31AB

TPC115WXXXXXXXXXX-T

TPC-121W

TPC-121W-N31YB

TPC-121W-N31AB

TPC121WXXXXXXXXXX-T

---

## Product Warranty (2 years)

Advantech warrants the original purchaser that each of its products will be free from defects in materials and workmanship for two years from the date of purchase.

This warranty does not apply to any products that have been repaired or altered by persons other than repair personnel authorized by Advantech, or products that have been subject to misuse, abuse, accident, or improper installation. Advantech assumes no liability under the terms of this warranty as a consequence of such events.

Because of Advantech's high quality-control standards and rigorous testing, most customers never need to use our repair service. If an Advantech product is defective, it will be repaired or replaced free of charge during the warranty period. For out-of-warranty repairs, customers will be billed according to the cost of replacement materials, service time, and freight. Please consult your dealer for more details.

If you believe your product to be defective, follow the steps outlined below.

1. Collect all the information about the problem encountered. (For example, CPU speed, Advantech products used, other hardware and software used, etc.) Note anything abnormal and list any onscreen messages displayed when the problem occurs.
2. Call your dealer and describe the problem. Please have your manual, product, and any helpful information readily available.
3. If your product is diagnosed as defective, obtain a return merchandise authorization (RMA) number from your dealer. This allows us to process your return more quickly.
4. Carefully pack the defective product, a completed Repair and Replacement Order Card, and a proof of purchase date (such as a photocopy of your sales receipt) into a shippable container. Products returned without a proof of purchase date are not eligible for warranty service.
5. Write the RMA number clearly on the outside of the package and ship the package prepaid to your dealer.

## Technical Support and Assistance

1. Visit the Advantech website at [www.advantech.com/support](http://www.advantech.com/support) to obtain the latest product information.
2. Contact your distributor, sales representative, or Advantech's customer service center for technical support if you need additional assistance. Please have the following information ready before calling:
  - Product name and serial number
  - Description of your peripheral attachments
  - Description of your software (operating system, version, application software, etc.)
  - A complete description of the problem
  - The exact wording of any error messages



# Declaration of Conformity

## CE

This product has passed the CE test for environmental specifications when shielded cables are used for external wiring. We recommend the use of shielded cables. This type of cable is available from Advantech. Please contact your local supplier for ordering information.

Test conditions for passing also include the equipment being operated within an industrial enclosure. In order to protect the product from damage caused by electrostatic discharge (ESD) and EMI leakage, we strongly recommend the use of CE-compliant industrial enclosure products.

## FCC Class A

This equipment has been tested and found to comply with the limits for a Class A digital device, pursuant to part 15 of the FCC Rules. These limits are designed to provide reasonable protection against harmful interference when the equipment is operated in a commercial environment. This equipment generates, uses, and can radiate radio frequency energy and, if not installed and used in accordance with the instruction manual, may cause harmful interference to radio communications. Operation of this equipment in a residential area is likely to cause harmful interference. In this event, users are required to correct the interference at their own expense.

## 甲類資訊技術設備

甲類設備為其他符合甲類設備限制值之資訊技術設備，而非符合乙類資訊技術設備的限制值；雖然不可限制此類設備之行銷，但使用場所必須被限制，不得進行居住的環境中，且應於其機器本體及使用說明書中含有下列警語：

**警告使用者：**

此為甲類資訊技術設備，於居住環境中使用時，可能會造成射頻擾動，在此種情況下，使用者會被要求採取某些適當的對策。

## Warnings, Cautions, and Notes

**Warning!** Warnings indicate conditions that if not observed can cause personal injury!



Les avertissements indiquent des conditions qui, si elles ne sont pas respectées, peuvent blesser!

**Warning!** Do not expose the equipment to direct sunlight, or install the equipment in an environment with direct sunlight, as this may cause damage.



N'exposez pas l'équipement à la lumière directe du soleil et n'installez pas l'équipement dans un environnement exposé à la lumière directe du soleil, car cela pourrait causer des dommages.

**Caution!** Cautions are included to help prevent hardware damage and data losses. For example,



“Batteries are at risk of exploding if incorrectly installed. Do not attempt to recharge, force open, or heat the battery. Replace the battery only with the same or equivalent type as recommended by the manufacturer. Discard used batteries according to the manufacturer's instructions.”

Des précautions sont incluses pour aider à prévenir les dommages matériels et les données pertes. Par exemple,

Les piles risquent d'exploser si elles sont mal installées. Ne pas tenter pour recharger, forcer l'ouverture ou chauffer la batterie. Remplacer la batterie uniquement avec le même type ou un type équivalent recommandé par le fabricant. Jetez les piles usagées conformément aux instructions du fabricant.

**Note!** Notes provide additional optional information.



Les remarques fournissent des informations facultatives supplémentaires.

# Safety Instructions

1. Read these safety instructions carefully.
2. Retain this user manual for future reference.
3. Disconnect the equipment from all power outlets before cleaning. Use only a damp cloth for cleaning. Do not use liquid or spray detergents.
4. For pluggable equipment, the power outlet socket must be located near the equipment and easily accessible.
5. Protect the equipment from humidity.
6. Place the equipment on a reliable surface during installation. Dropping or letting the equipment fall may cause damage.
7. The openings on the enclosure are for air convection. Protect the equipment from overheating. Do not cover the openings.
8. Ensure that the voltage of the power source is correct before connecting the equipment to a power outlet.
9. Position the power cord away from high-traffic areas. Do not place anything over the power cord.
10. All cautions and warnings on the equipment should be noted.
11. If the equipment is not used for a long time, disconnect it from the power source to avoid damage from transient overvoltage.
12. Never pour liquid into an opening. This may cause fire or electrical shock.
13. Never open the equipment. For safety reasons, the equipment should be opened only by qualified service personnel.
14. If any of the following occurs, have the equipment checked by service personnel:
  - The power cord or plug is damaged.
  - Liquid has penetrated the equipment.
  - The equipment is malfunctioning, or does not operate according to the user manual.
  - The equipment has been dropped and damaged.
  - The equipment shows obvious signs of breakage.
15. Do not leave the equipment in an environment with a storage temperature of below  $-30^{\circ}\text{C}$  ( $-22^{\circ}\text{F}$ ) or above  $70^{\circ}\text{C}$  ( $158^{\circ}\text{F}$ ) as this may damage the components. The equipment should be kept in a controlled environment.
16. **CAUTION:** Batteries are at risk of exploding if incorrectly replaced. Replace only with the same or equivalent type as recommended by the manufacturer. Discard used batteries according to the manufacturer's instructions.
17. In accordance with IEC 704-1:1982 specifications, the sound pressure level at the operator's position does not exceed 70 dB (A).
18. This product is not intended for use by children (this product is not a toy).
19. This equipment is not suitable for use in locations where children are likely to be present.
20. By means of a power cord connected to a socket-outlet with earthing connection.

Assurez-vous que la tension de la source d'alimentation est correcte avant de connecter l'équipement à la prise de courant. Au moyen d'un cordon d'alimentation connecté à une prise de courant avec mise à la terre.
21. **Caution:** The wire of the protective bonding conductor shall be green-and-yellow, 22AWG/0.3mm<sup>2</sup> minimum.

Attention: Le fil du conducteur de liaison de protection doit être vert et jaune, 22AWG/0,3 mm<sup>2</sup> minimum.

**DISCLAIMER:** These instructions are provided according to IEC 704-1 standards. Advantech disclaims all responsibility for the accuracy of any statements contained herein.

**Caution!** *Danger d'explosion si la batterie est mal remplacée. Remplacer uniquement par le même type ou équivalent recommandé par le fabricant. Jeter les piles usagées selon les instructions du fabricant.*



## 安全指示

1. 請仔細閱讀此安全操作說明。
2. 請妥善保存此用戶手冊供日後參考。
3. 用濕抹布清洗設備前，請從插座拔下電源線。請不要使用液體或去汙噴霧劑清洗設備。
4. 對於使用電源線的設備，設備周圍必須有容易接觸到的電源插座。
5. 請不要在潮濕環境中使用設備。
6. 請在安裝前確保設備放置在可靠的平面上，意外跌落可能會導致設備損壞。
7. 設備外殼的開口是用於空氣對流，從而防止設備過熱。**請不要覆蓋這些開口。**
8. 當您連接設備到電源插座上前，請確認電源插座的電壓是否符合要求。
9. 請將電源線佈置在人們不易絆到的位置，並不要在電源線上覆蓋任何雜物。
10. 請注意設備上的所有警告和注意標示。
11. 如果長時間不使用設備，請將其同電源插座斷開，避免設備被超標的電壓波動損壞。
12. 請不要讓任何液體流入通風口，以免引起火災或者短路。
13. 請不要自行打開設備。為了確保您的安全，請由經過認證的工程師來打開設備。
14. 如遇下列情況，請由專業人員來維修：
  - 電源線或者插頭損壞；
  - 設備內部有液體流入；
  - 設備曾暴露在過於潮濕的環境中使用；
  - 設備無法正常工作，或您無法通過用戶手冊來使其正常工作；
  - 設備跌落或者損壞；
  - 設備有明顯的外觀破損。
15. 請不要把設備保存在超出我們建議的溫度範圍的環境，即不要低於  $-30^{\circ}\text{C}$  ( $-4^{\circ}\text{F}$ ) 或高於  $70^{\circ}\text{C}$  ( $140^{\circ}\text{F}$ )，否則可能會損壞設備。
16. **注意：**如果電池放置不正確，將有爆炸的危險。因此，只可以使用製造商推薦的同一種或者同等型號的電池進行替換。請按照製造商的指示處理舊電池。
17. 根據 IEC 704-1:1982 的規定，操作員所在位置的音量不可高於 70dB(A)。
18. 限制區域：請勿將設備安裝於限制區域使用。
19. **免責聲明：**該安全指示符合 IEC 704-1 的要求。研華公司對其內容的準確性不承擔任何法律責任。
20. 使用過度恐傷害視力。
21. 使用 30 分鐘請休息 10 分鐘。
22. 未滿 2 歲幼兒不看螢幕，2 歲以上每天看螢幕不要超過 1 小時。
23. 本產品為國內裝置使用時，其電源僅限使用架構電源模組所提供電源直流輸入，不得使用交流電源及附加其他電源轉換裝置提供電源這者，其電源輸入電壓及電流請依說明書規定使用。

## Wichtige Sicherheitshinweise

1. Bitte lesen sie Sich diese Hinweise sorgfältig durch.
2. Heben Sie diese Anleitung für den späteren Gebrauch auf.
3. Vor jedem Reinigen ist das Gerät vom Stromnetz zu trennen. Verwenden Sie Keine Flüssig-oder Aerosolreiniger. Am besten dient ein angefeuchtetes Tuch zur Reinigung.
4. Die Netzanschlussteckdose soll nahe dem Gerät angebracht und leicht zugänglich sein.
5. Das Gerät ist vor Feuchtigkeit zu schützen.
6. Bei der Aufstellung des Gerätes ist auf sicheren Stand zu achten. Ein Kippen oder Fallen könnte Verletzungen hervorrufen.
7. Die Belüftungsöffnungen dienen zur Luftzirkulation die das Gerät vor überhitzung schützt. Sorgen Sie dafür, dass diese Öffnungen nicht abgedeckt werden.
8. Beachten Sie beim Anschluss an das Stromnetz die AnschluBwerte.
9. Verlegen Sie die Netzanschlussleitung so, dass niemand darüber fallen kann. Es sollte auch nichts auf der Leitung abgestellt werden.
10. Es sollte auch nichts auf der Leitung abgestellt werden. Alle Hinweise und Warnungen die sich am Ger?ten befinden sind zu beachten.
11. Wird das Gerät über einen längeren Zeitraum nicht benutzt, sollten Sie es vom Stromnetz trennen. Somit wird im Falle einer Überspannung eine Beschädigung vermieden.
12. Durch die Lüftungsöffnungen dürfen niemals Gegenstände oder Flüssigkeiten in das Gerät gelangen. Dies könnte einen Brand bzw. elektrischen Schlag auslösen.
13. Öffnen Sie niemals das Gerät. Das Gerät darf aus Gründen der elektrischen Sicherheit nur von autorisiertem Servicepersonal geöffnet werden.
14. Wenn folgende Situationen auftreten ist das Gerät vom Stromnetz zu trennen und von einer qualifizierten Servicestelle zu überprüfen:
  - Netzkabel oder Netzstecker sind beschädigt.
  - Flüssigkeit ist in das Gerät eingedrungen.
  - Das Gerät war Feuchtigkeit ausgesetzt.
  - Wenn das Gerät nicht der Bedienungsanleitung entsprechend funktioniert oder Sie mit Hilfe dieser Anleitung keine Verbesserung erzielen.
15. **VORSICHT:** Explosionsgefahr bei unsachgemäßen Austausch der Batterie.Ersatz nur durch denselben oder einem vom Hersteller empfohlene-mähnlichen Typ. Entsorgung gebrauchter Batterien navh Angaben des Herstellers.
16. **ACHTUNG:** Es besteht die Explosionsgefahr, falls die Batterie auf nicht fachmännische Weise gewechselt wird. Verfangen Sie die Batterie nur gleicher oder entsprechender Type, wie vom Hersteller empfohlen. Entsorgen Sie Batterien nach Anweisung des Herstellers.
17. Der arbeitsplatzbezogene Schalldruckpegel nach DIN 45 635 Teil 1000 beträgt 70dB(A) oder weiger.
18. Haftungsausschluss: Die Bedienungsanleitungen wurden entsprechend der IEC-704-1 erstellt. Advantech lehnt jegliche Verantwortung für die Richtigkeit der in die- sem Zusammenhang getätigten Aussagen ab.
19. Assurez-vous que la tension de la source d'alimentation est correcte avant de connecter l'équipement à la prise de courant. Au moyen d'un cordon d'alimentation connecté à une prise de courant avec mise à la terre.
20. Attention: Le fil du conducteur de liaison de protection doit être vert et jaune, 22AWG/0,3 mm<sup>2</sup> minimum.

---

## Safety Precaution - Static Electricity

Follow these simple precautions to protect yourself from harm and the products from damage.

- To avoid electrical shock, always disconnect the power from your PC chassis before you work on it. Don't touch any components on the CPU card or other cards while the PC is on.
- Disconnect power before making any configuration changes. The sudden rush of power as you connect a jumper or install a card may damage sensitive electronic components.

# Contents

<b>Chapter 1</b>	<b>General Information .....</b>	<b>1</b>
1.1	Introduction .....	2
1.1.1	Accessories Ordering P/N.....	2
1.2	Specifications .....	3
1.2.1	System Kernel.....	3
1.2.2	Communication Interface .....	3
1.2.3	LCD Panel.....	3
1.2.4	Touchscreen .....	3
1.2.5	Environment.....	4
1.2.6	EMC and Safety.....	4
1.2.7	Power.....	4
1.2.8	External I/O.....	4
1.3	Mounting .....	5
1.4	Dimensions and Cutout.....	6
<b>Chapter 2</b>	<b>System Setup.....</b>	<b>9</b>
2.1	Transport and Unpacking.....	10
2.2	System Configuration.....	11
2.3	M.2 Key-E 2230 Express and PoE Module Installation.....	14
2.3.1	M.2 Card Installation .....	14
2.3.2	PoE Module Installation .....	15
2.4	System Power on .....	19
2.4.1	Embedding the TPC-100W System and Earth Grounding Setup20	
<b>Chapter 3</b>	<b>Linux Yocto .....</b>	<b>23</b>
3.1	ARM Yocto 3.0 .....	24
3.2	ARM Yocto 3.0 Software Support .....	24
3.2.1	System Default Software .....	24
3.2.2	GPU Accelerations.....	24
3.2.3	Install Yocto 3.0 Software .....	25
3.2.4	First Login .....	28
3.3	TPC-100W Module Extension.....	29
3.3.1	Module Information .....	29
3.3.2	The Configuration and Connection of WIFI Module.....	29
3.3.3	The Configuration and Connection of Bluetooth Module .....	32
3.4	Time and Date Setting .....	34
3.5	CAN Setting .....	35
3.6	Brightness Setting .....	36
3.7	COM Setting.....	36
3.8	Firewall Setting.....	37
3.9	Recovery .....	37
3.10	GUI Settings Tool.....	38
3.11	Weston Keyboard Shortcuts .....	39
<b>Chapter 4</b>	<b>Android.....</b>	<b>41</b>
4.1	Android 10.....	42
4.2	Android 10 Software Support.....	42
4.2.1	System Default Software .....	42
4.2.2	Other Applications.....	42

4.3	Install Android Software .....	42
4.3.1	Create a Bootable SD Card .....	42
4.3.2	Boot from eMMC.....	44
4.4	Serial Port Sample .....	45
4.5	Kiosk Setting .....	46
4.5.1	Set the Kiosk Setting App as the Default Launcher .....	46
4.5.2	Set App as Kiosk App .....	47
4.5.3	Exit Kiosk App.....	48
4.5.4	Set WebView as Kiosk App .....	49
4.5.5	Show System App .....	50
4.5.6	Exit Kiosk Setting.....	51

## **Appendix A**      **Pin Assignments .....**      **53**

A.1	M.2 Slot (E-Key).....	54
A.2	COM Port .....	55



# Chapter 1

General Information

## 1.1 Introduction

The TPC-100W series is a compact touch panel computer equipped with an NXP® Cortex®-A53 i.MX8M Mini quad-core processor, 7"/10.1"/15.6"/21.5" TFT LCD display, multi-touch glass sensor, 16GB of eMMC Storage. To ensure stable operation in harsh industrial environments, TPC-100W supports a wide operating temperature range (-20 ~ 60° C/-4~140° F) and Panel mounting features an IP66-rated front panel that protects against water and dust ingress.

For web-based operations, TPC-100W offers two 10/100/1000 LANs that one supports the IEEE 802.3at PoE-PD standard. The inclusion of browsers enable rapid Web application development and easy configuration. Finally, TPC-100W supports various OS including Linux Ubuntu Desktop with full QT graphics and Android to ensure easy deployment for diverse applications.

- NXP® ARM Cortex®-A53 i.MX8M Mini Quad core processor
- 7" 16:9 WSVGA LCD wide screen with PCAP multi-touch
- 10.1" 16:9 WXGA LCD wide screen with PCAP multi-touch
- 15.6" HD WXGA LCD wide screen with PCAP multi-touch
- 15.6" FHD LCD wide screen with PCAP multi-touch
- 21.5" FHD LCD wide screen with PCAP multi-touch
- Up to 2GB LPDDR4 RAM & 16GB eMMC storage onboard
- 10/100/1000 Mbps LAN
- 1MB FRAM backup memory for power interruption situation
- 2 x Serial port with termination resistor 120Ω that one supports CAN 2.0B protocol specification and programmable bit rate up to 1 Mb/sec
- Yocto3.3 version supports Optional M.2 Wifi, Bluetooth, TPM.2.0 and POE (7" and 10.1" only) module expansion support
- Android 10 version supports Optional M.2 WiFi and PoE (7" and 10.1" only) module expansion support
- Panel mounting with true-flat IP66 front panel support
- -20 ~ 60° C wide operating temperature range

### 1.1.1 Accessories Ordering P/N

- **M.2 Key-E 2230 Express Module:** 98R4T100W01
- **PoE Module:** 98R4T100W00 (7" and 10.1" only)

## 1.2 Specifications

### 1.2.1 System Kernel

- **CPU:** NXP® ARM Cortex®-A53 i.MX8 Mini Quad Core 1.6 GHz Processor
- **Memory:** Quad Core: 2GB DDR4 RAM on board
- **Storage Memory:** 16GB eMMC on board; 1MB FRAM for data backup
- **Watchdog Timer:** Programmable as 1 second

### 1.2.2 Communication Interface

- **Serial Port:**
  - 1 x RS-232/422/485 (COM 1)
  - 1 x selectable mode for RS485 and CAN 2.0 B
- **LAN Port:** 2 x RJ45 with 10/100/1000 Mbps LAN
- **Others:**
  - 1 x USB 2.0 Micro USB Client
  - 2 x USB 2.0 Type-A Host 1 x Micro SD (Internal)
  - 1 x M.2 Key-E 2230 (Wi-fi/BT)

### 1.2.3 LCD Panel

Category	Item	7"	10.1"	15.6" (HD)	15.6" (FHD)	21.5"(FHD)
LCD	<b>Display Type</b>	WSGA TFT LCD	WXGA TFT LCD	WXGA TFT LCD	FHD TFT LCD	FHD TFT LCD
	<b>Max. Resolution</b>	1024 x 600	1280 x 800	1366 x 768	1920 x 1080	1920 x 1080
	<b>Aspect Ratio</b>	16:9	16:10	16:9	16:9	16:9
	<b>Max. Color</b>	16.7 M	16.2M	16.7 M	16.2 M	16.7 M
	<b>Luminance (cd/m<sup>2</sup>)</b>	425	500	300	450	250
	<b>Viewing Angle (H/V°)</b>	170/170	170/170	160/160	170/170	89/89
	<b>Backlight Life</b>	50,000hrs	50,000hrs	50,000hrs	50,000hrs	50000hrs
	<b>Contrast Ratio</b>	800:1	800:1	500:1	800:1	1000:1
Touch	<b>Type</b>	Projected capacitive	Projected capacitive	Projected capacitive	Projected capacitive	Projected capacitive
	<b>Transmission</b>	88% ± 2%	88% ± 2%	88% ± 2%	88% ± 2%	88% ± 2%
System Temperature	<b>Operating</b>	-20 ~ 60 °C (-4 ~ 140 °F)	-20 ~ 60 °C (-4 ~ 140 °F)	-20 ~ 60 °C (-4 ~ 140 °F)	-20 ~ 60 °C (-4 ~ 140 °F)	0~60°C (32~140 °F)
	<b>Storage</b>	-30 ~ 70 °C (-22 ~ 158 °F)	-30 ~ 70 °C (-22 ~ 158 °F)	-30 ~ 70 °C (-22 ~ 158 °F)	-30 ~ 70 °C (-22 ~ 158 °F)	-20 ~ 60 °C (-4 ~ 140 °F)

### 1.2.4 Touchscreen

- **Touch Points:** 10 Points
- **Light Transmission:** above 85%
- **Pencil Hardness:** 7H
- **Type:** Projected capacitive (P-CAP) touch

## 1.2.5 Environment

- **Operating Temperature:**
  - 7"/10.1"/15.6": -20 ~ 60 °C (-4 ~ 140 °F)  
The Temperature of Safety Certification is from -20~50°C (-4~122 °F)
  - 21.5": 0~60°C(32~140 °F)  
The Temperature of Safety Certification is from -20 ~ 50 °C (-4 ~ 122 °F)
- **Storage Temperature:**
  - 7"/10.1"/15.6" : -30 ~ 70 °C (-22 ~ 158 °F)
  - 21.5": -20 ~ 60 °C(-4 ~ 140 °F)
- **Humidity:** 10 ~ 90% RH @ 40 °C, non-condensing
- **Ingress Protection:** Compliant with IP66 on front panel
- **Vibration Protection:** 2 Grms random vibration (5 ~ 500 Hz) during operation (compliant with IEC60068-2-64)
- **Shock Protection:** 10 G shock under 11 ms operation (compliant with IEC60068-2-27)

## 1.2.6 EMC and Safety

- **EMC:** CE, FCC Class A, BSMI
- **Safety:** CB, UL, CCC

## 1.2.7 Power

- **Input Voltage:** 24Vdc ± 20% or PoE+ Power Input - IEEE 802.3at PD required on LAN B
- **Power Consumption:**
  - TPC-107W: 6W (Typ.); 9W (Max.)
  - TPC-110W: 10W (Typ.); 12W (Max.)
  - TPC-115W: 13W (Typ.); 16W (Max.)

## 1.2.8 External I/O

The arrangement of I/O ports is shown below.

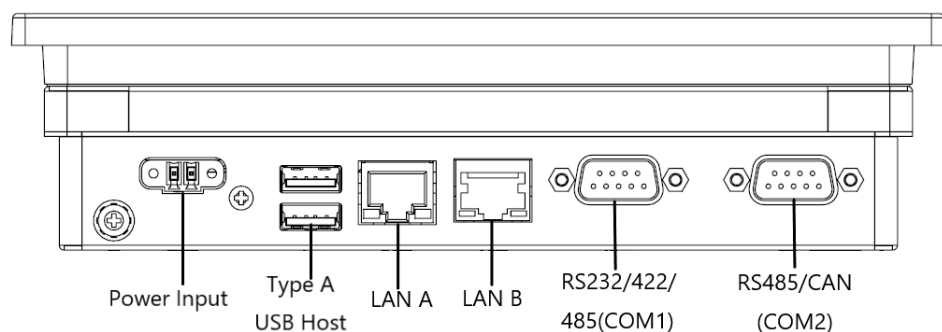

## 1.3 Mounting

### ■ VESA Mount

The TPC-100 rear cover features four VESA mounting (100 x 100 mm) holes. The VESA mounting kit needs to be installed by 4pcs M4x10L screws. Please use suitable mounting apparatus to avoid risk of injury.

### ■ Panel Mount

There is an adhesive waterproof gasket on the front bezel. Make sure the waterproof gasket is in position before installing a TPC-100W panel computer into the panel opening.

1. Install the TPC into the panel opening.
2. Find the six clamps and six long screws in the accessory pack. Hook the clamps to the holes around the four sides of the bezel. Insert the screws into every clamp and fasten them. These screws will push the mounting panel and fix the unit.
3. The suggested mounting panel thickness is less than 6 mm (0.236").

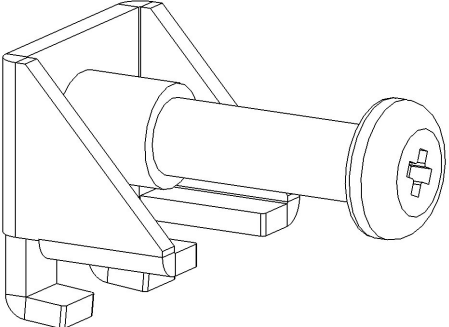
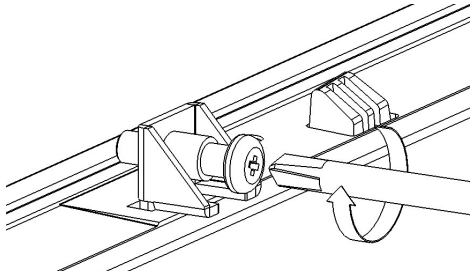
	<p>Insert the screws into each clamp and tighten them to fasten the clamp in place.</p>
	<p>Hook the clamp into the holes and fasten the screws (Torque: 5 kgf-cm) These screws will push the mounting panel and secure the unit.</p>

Size	W7	W10	W15
Screw (M4 x 25mm) & Clamper Q'ty	4	8	10

## 1.4 Dimensions and Cutout

### TPC-107W

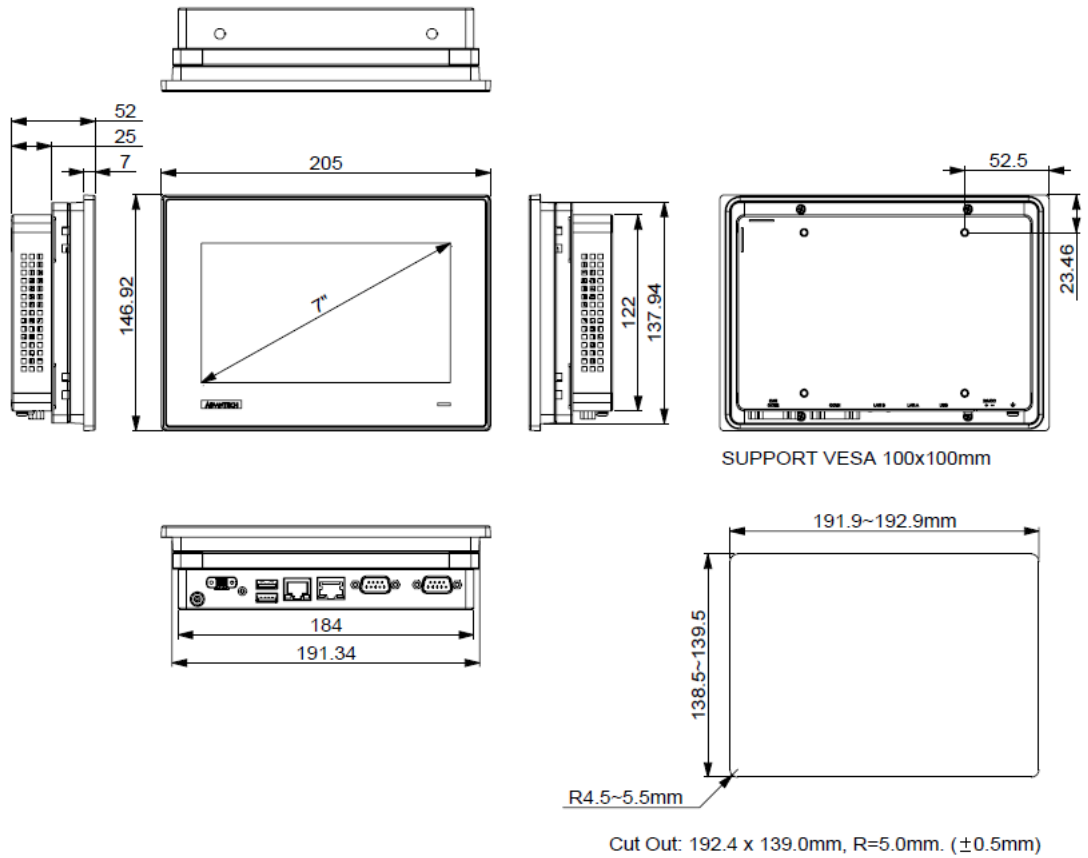

### TPC-110W

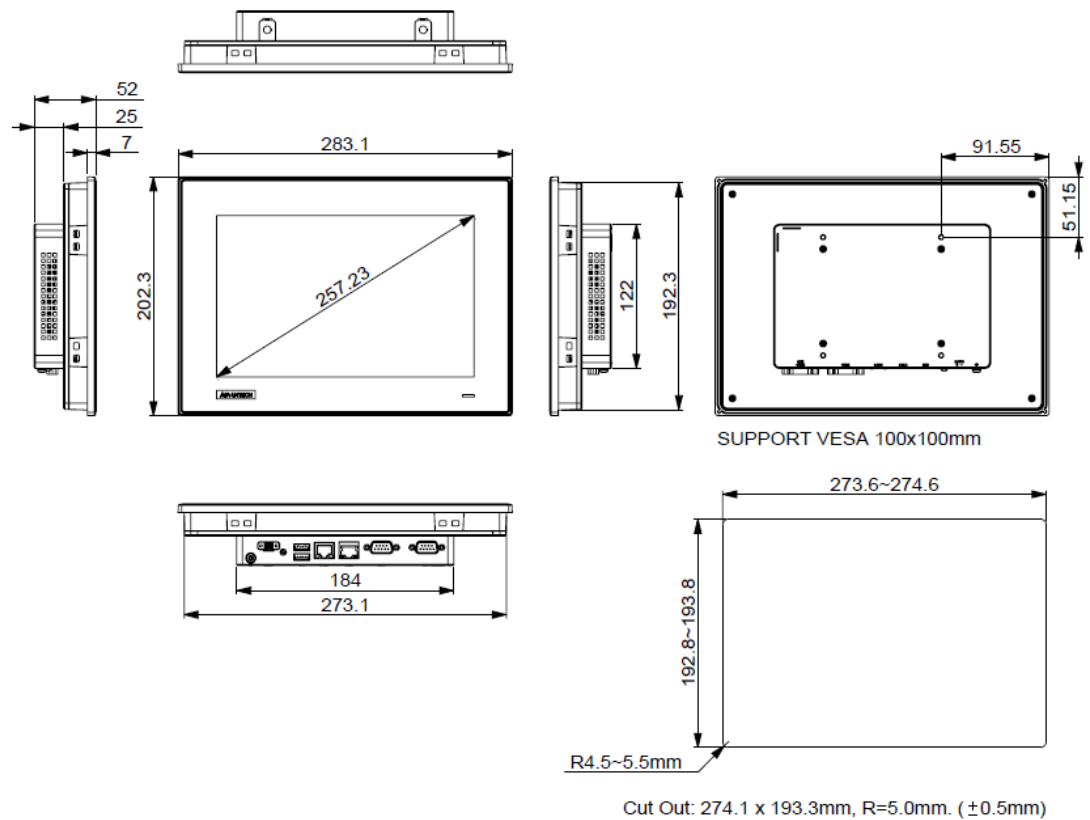

TPC-115W

Unit: mm

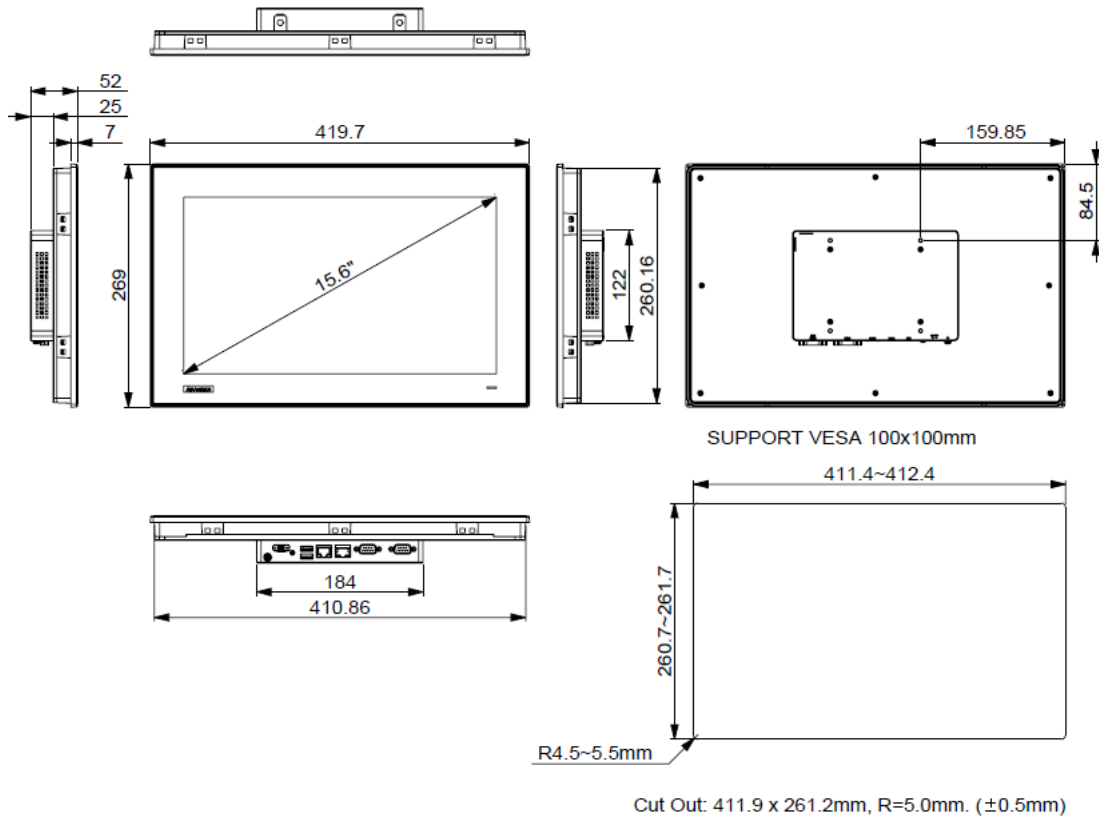

TPC-121W

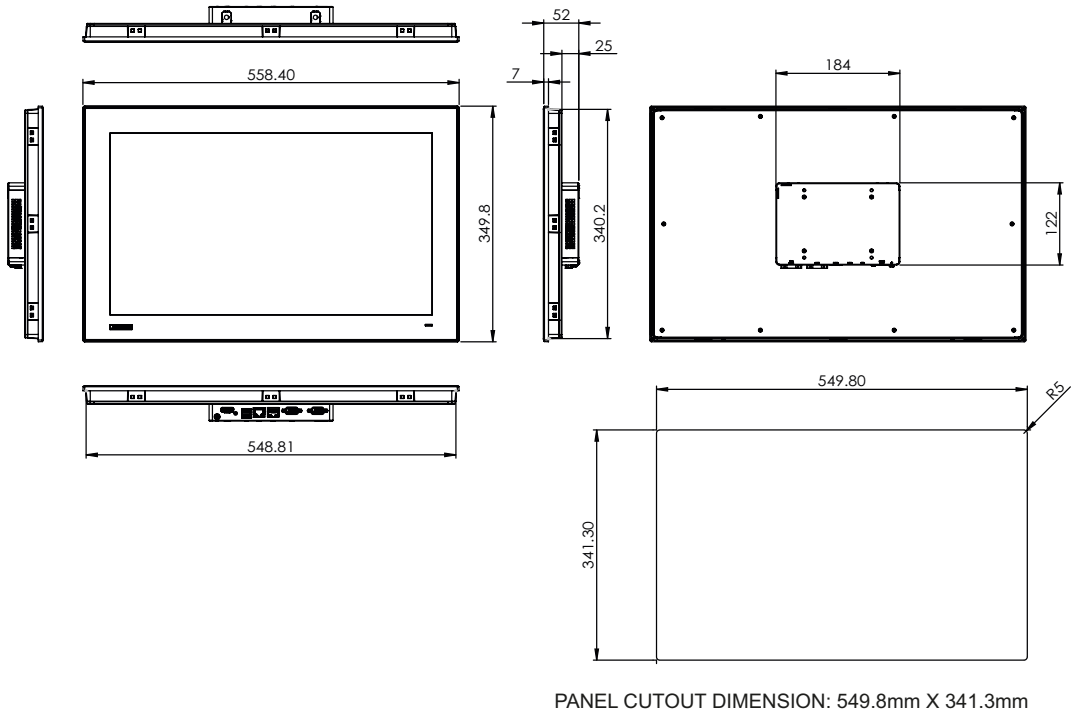

---

### LED Indicator

Off - "dark"

ON - "Blue"

Standby - "orange"

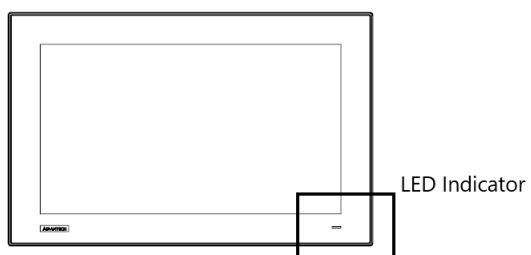



# Chapter 2

System Setup

---

## 2.1 Transport and Unpacking

When accepting a delivery, please check the packaging for visible transportation damage and check the delivery for completeness by comparing it with your order form. If you notice any shipping damage or inconsistencies between the contents and your order, please inform the responsible delivery service immediately. During transportation, the TPC system should be protected from excessive mechanical stress. If the TPC system is transported or stored without packaging, shocks, vibrations, pressure, and moisture may impact the unprotected unit. Additionally, damaged packaging indicates that ambient conditions have already had a massive impact on the device. Therefore, please use the original packaging during transportation and storage. If the TPC system is transported in cold weather or is exposed to extreme variations in temperature ensure that moisture (condensation) does not build up on or inside the HMI device. Moisture can result in short circuits and damage to the device. To avoid this, store the TPC system in a dry environment and bring the system to room temperature before powering it up. If condensation occurs, a delay time of approximately 12 hours must be allowed to ensure that the system is completely dry before being switched on.

## 2.2 System Configuration

TPC-100W is a compact touch panel with IIoT functions for industrial applications. The system setup will be completed by the dealer or system integrator prior to delivery. However, users may still need to access the system to adjust configuration, such as the interface or boot modes. Before powering on, please open the rear bracket and select the correct mode. Configuration can be set via the switch on the TPC-100W rear board as shown below.

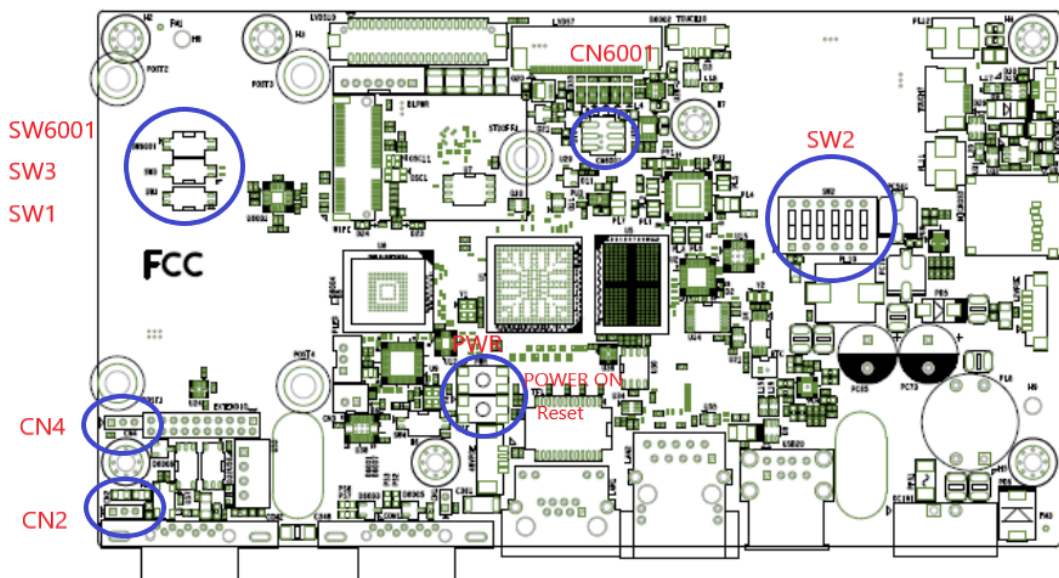

The default setting is RS232 mode and eMMC Boot. Kindly refer to the following pin definition table for mode switch.

### ■ Boot Mode: option (SW2)

SD boot (Install image)

1. OFF
2. ON
3. ON

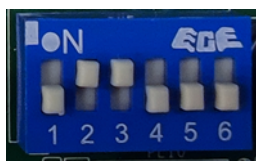

eMMC boot default

1. ON
2. OFF
3. OFF

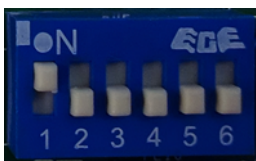

■ 7"

---

CN6001  
CN6001(1-3,2-4)

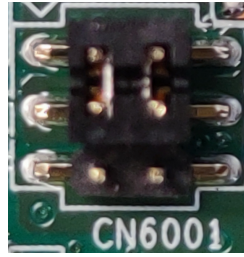

SW6001  
1.ON  
2.OFF

---

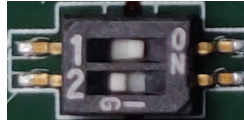

■ 10"

---

CN6001  
CN6001(1-3,2-4)

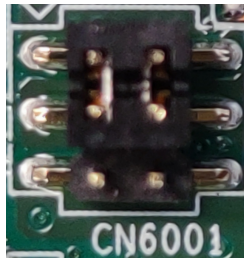

SW6001  
1.ON  
2.OFF

---

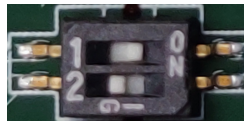

■ 15" HD

---

CN6001  
CN6001(3-5,4-6)

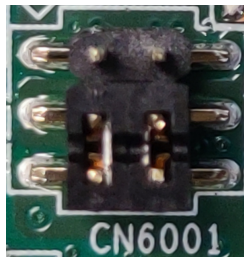

SW6001  
1.ON  
2.OFF

---

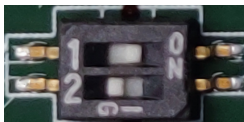

■ 15" FHD

CN6001  
CN6001(3-5,4-6)

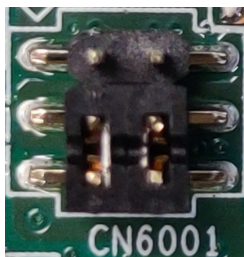

SW6001  
1.ON  
2.OFF

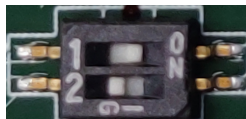

■ 21" FHD

CN6001  
CN6001(3-5,4-6)

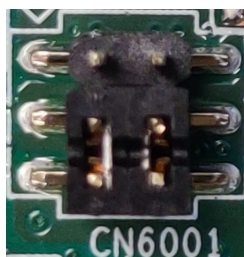

SW6001  
1.ON  
2.OFF

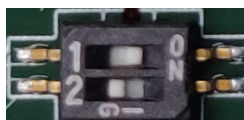

■ AT/ATX(SW1)

AT  
2.ON  
1.OFF

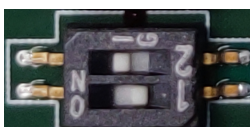

ATX  
2.OFF  
1.ON

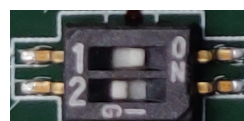

## 2.3 M.2 Key-E 2230 Express and PoE Module Installation

### 2.3.1 M.2 Card Installation

TPC-100W provides M.2 key Express slot and allows users to expend functions like Wi-Fi and Bluetooth type modules. Open the rear bracket and configure the M.2 module. (Refer to Appendix A1 for the detailed M.2 Slot E-Key).

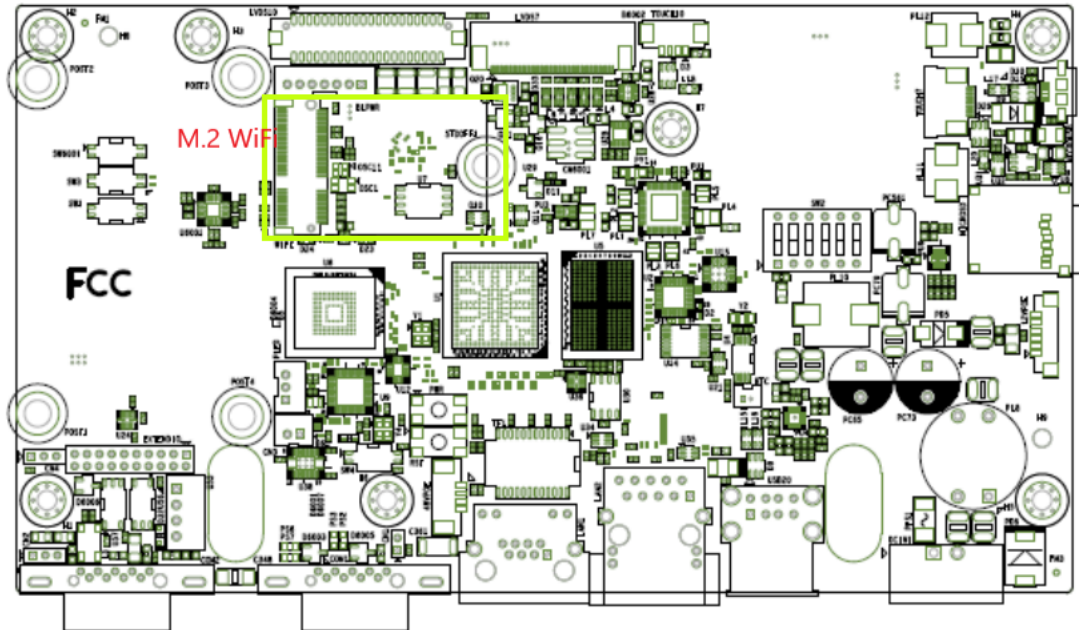

## 2.3.2 PoE Module Installation

1. Remove the post x4.

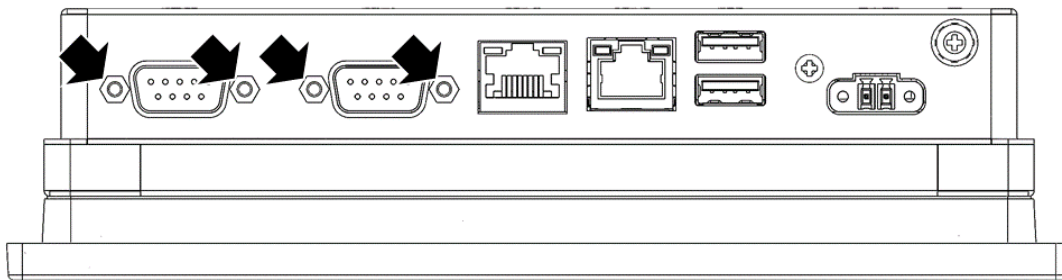

2. Remove the screw x4.

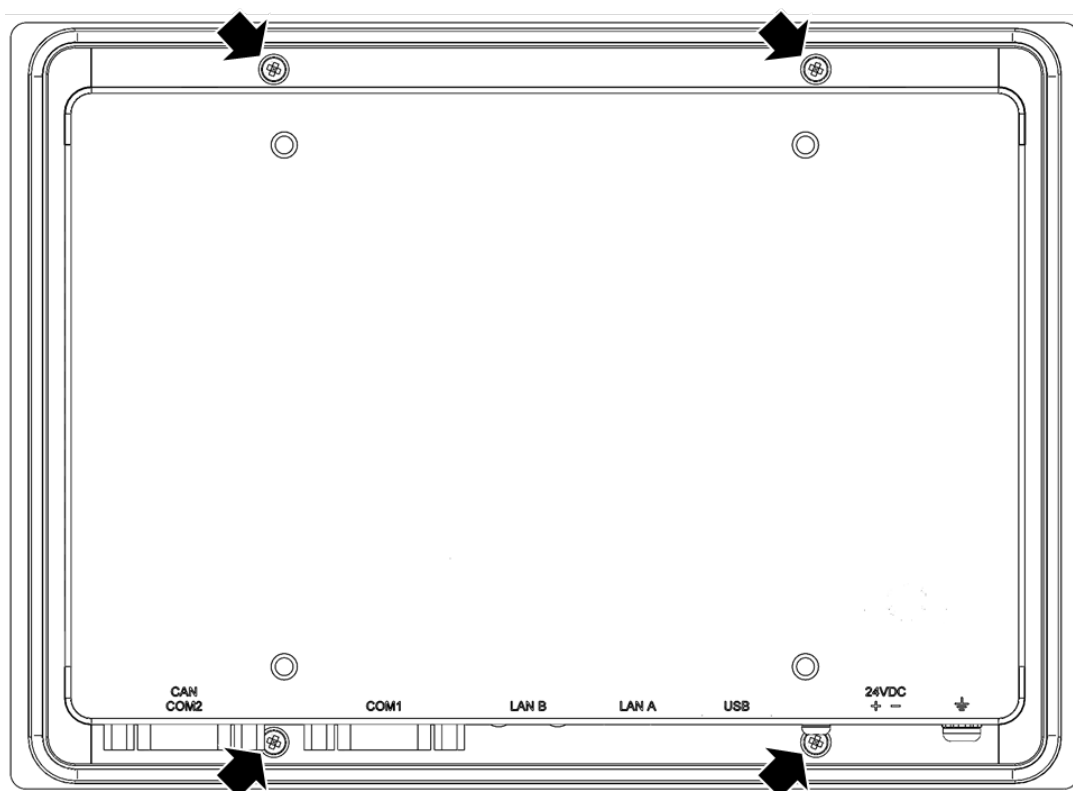

3. Remove the rear cover.

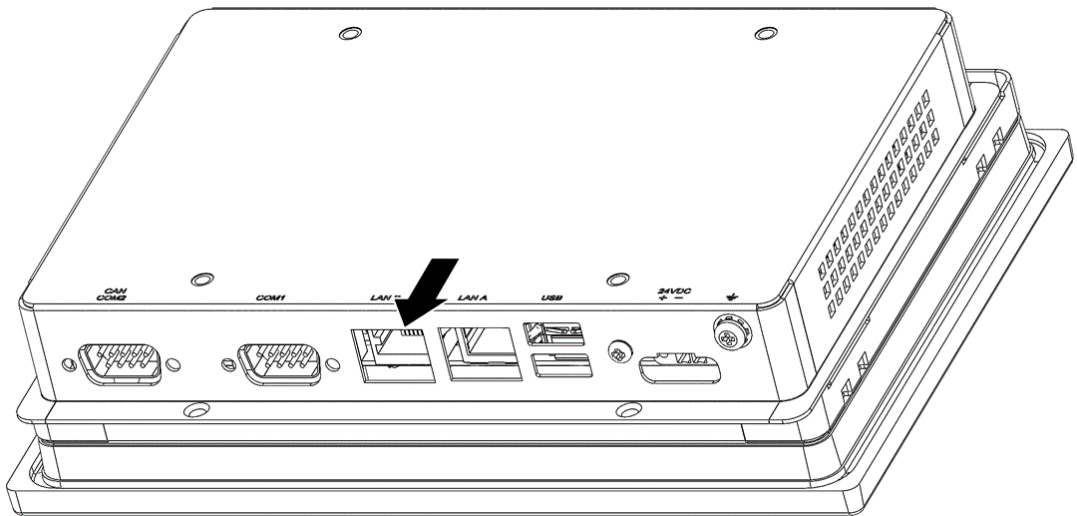

4. Fix Module PCB by Screw x4(Screw PN:1930002181, Screw M2.5x4L R/S D=4.3 H=1.6 (1+) ST Ni NK).

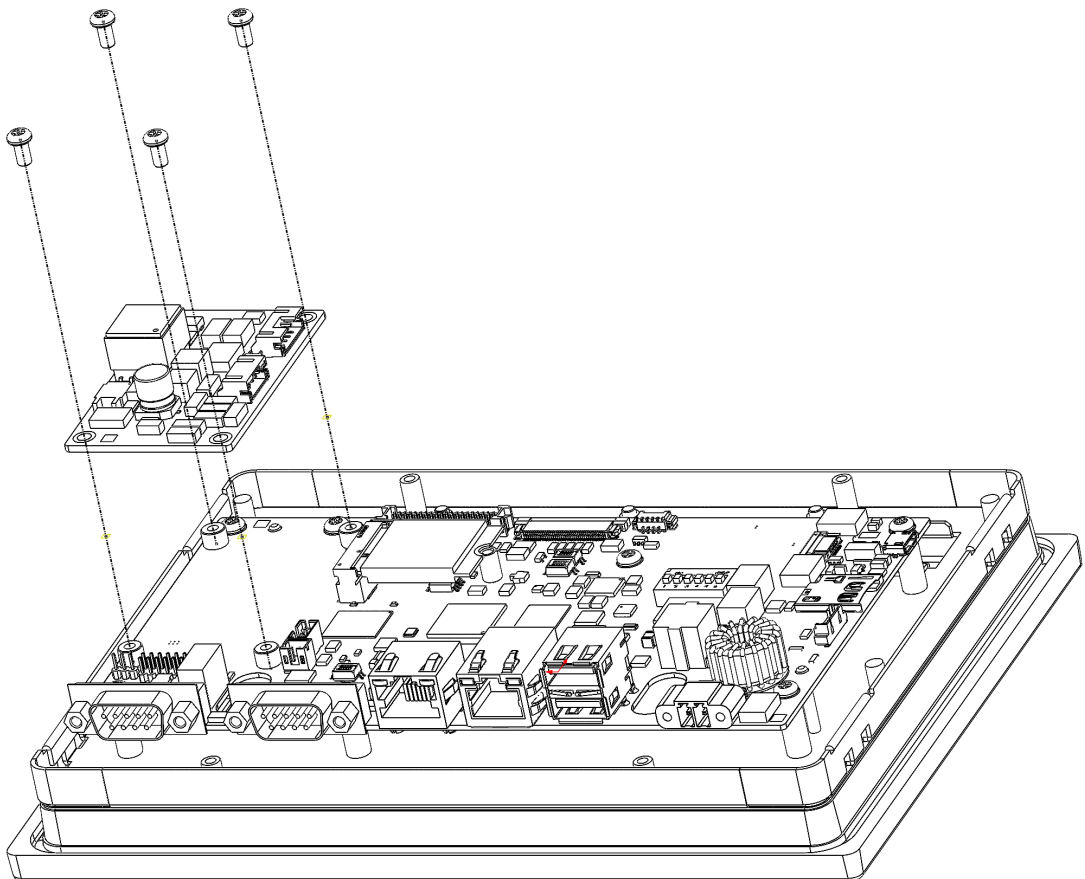



5. Connect cable x2.

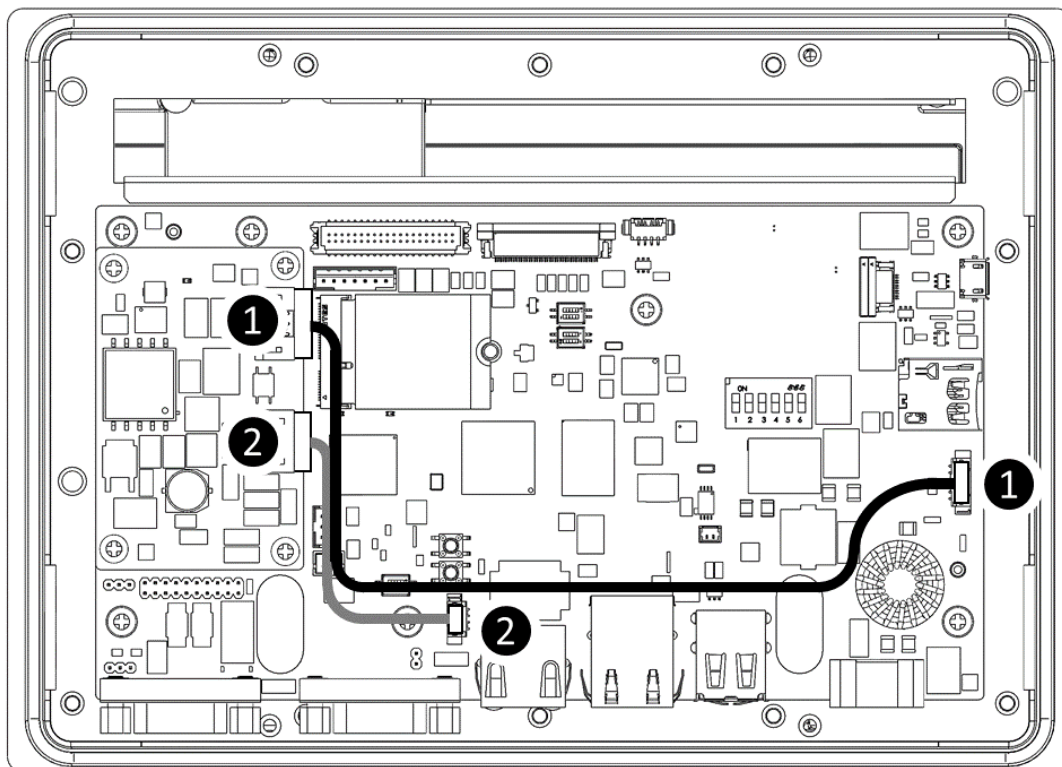

6. Put back the rear cover.

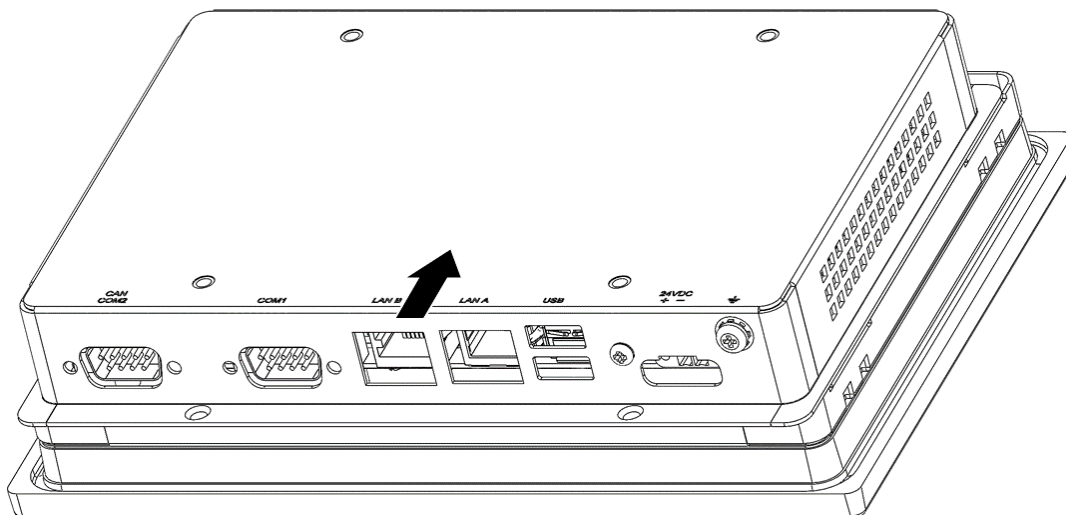

7. Fix the screw x4.

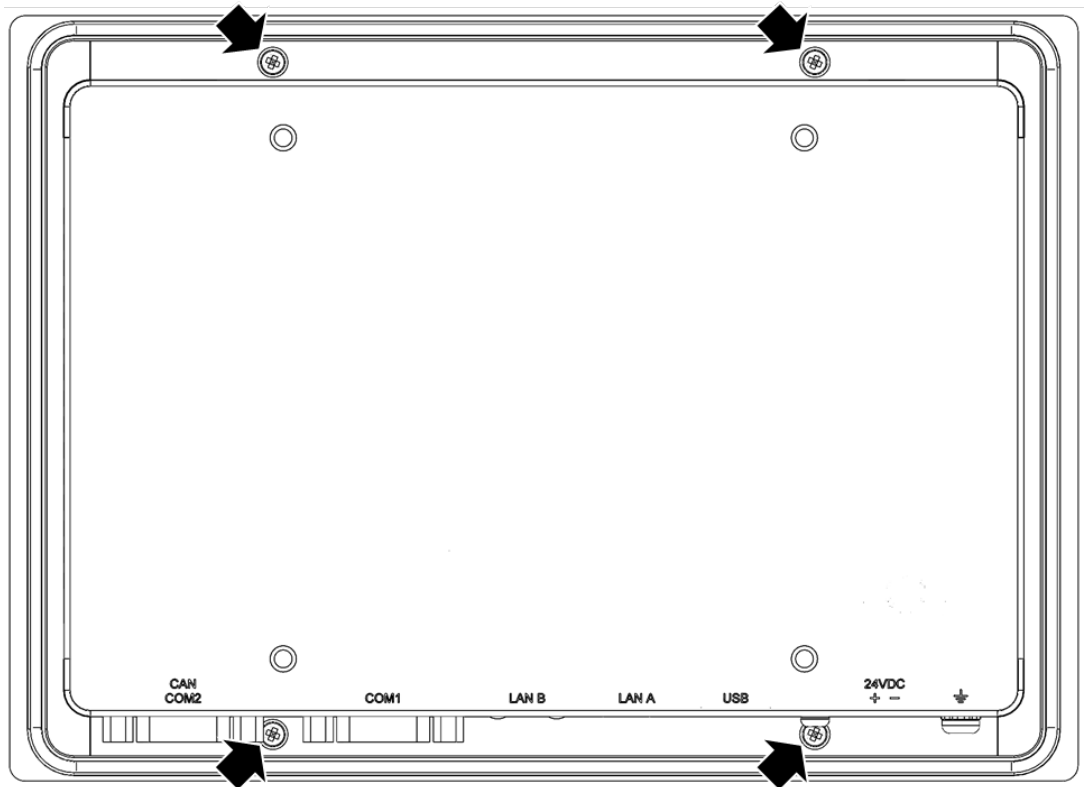

8. Fix the post x4.

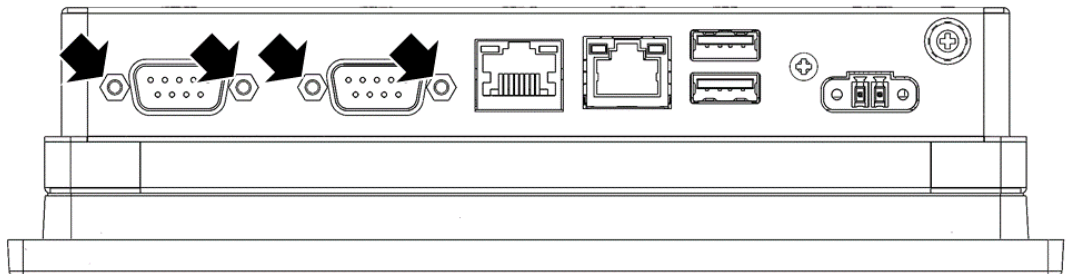

## 2.4 System Power on

A 2-pin power connector is included in the accessory box. Connect the power connector to Vdc power lines and plug the power lines into the system power receptor. DC power source shall be complied with ES1 and PS2 (LPS) requirements, output rating is 24 Vdc, minimum 0.83A or 48Vdc, minimum 0.53A, with minimum operating temperature 60° C, and has to be evaluated according to IEC/UL 62368-1.

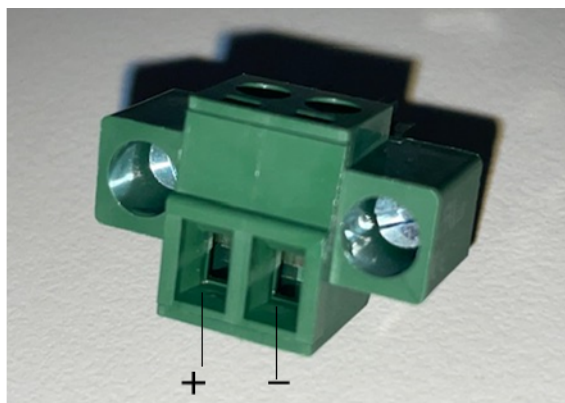

The terminal block is suitable for 16~26 AWG(10A). Torque value 2.5 lb-in. User copper conductors only. Must be installed by skilled person.

**Warning!** *The system may get damaged when the power is turned on and the power source is not connected to the correct pins.*



*Le système peut être endommagé lors de la mise sous tension et la source d'alimentation n'est pas connectée aux bonnes broches.*

**Warning!** *The PoE networks without routing to the outside plant, or equivalent.*



*Les réseaux PoE sans routage vers l'installation extérieure, ou équivalent.*

## 2.4.1 Embedding the TPC-100W System and Earth Grounding Setup

Follow the following steps to setup TPC-100W system, and please pay attention that Ground pin of TPC-100W system should be connected to earth ground. Under this circumstance, TPC-100W system could have the best performance such as EMI immunity, ESD immunity, Surge immunity and also system isolation. If the TPC-100W system is embedded in the cabinet, the TPC-100W system's ground, cabinet's ground and earth ground should be connected together.

1. Install the TPC-100W system into the cabinet.

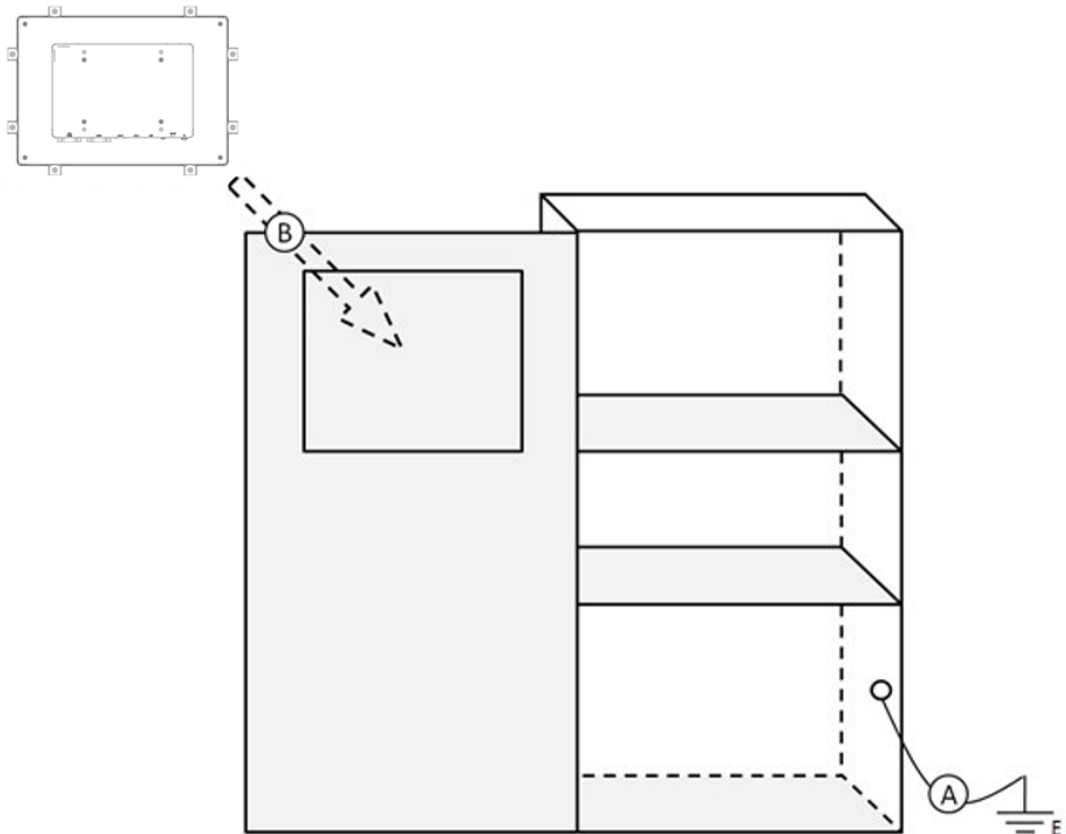

A: Connect the cabinet to earth ground.

B: Embed the TPC-100W system into the cabinet without any I/O cable and power.

## 2. System wiring.

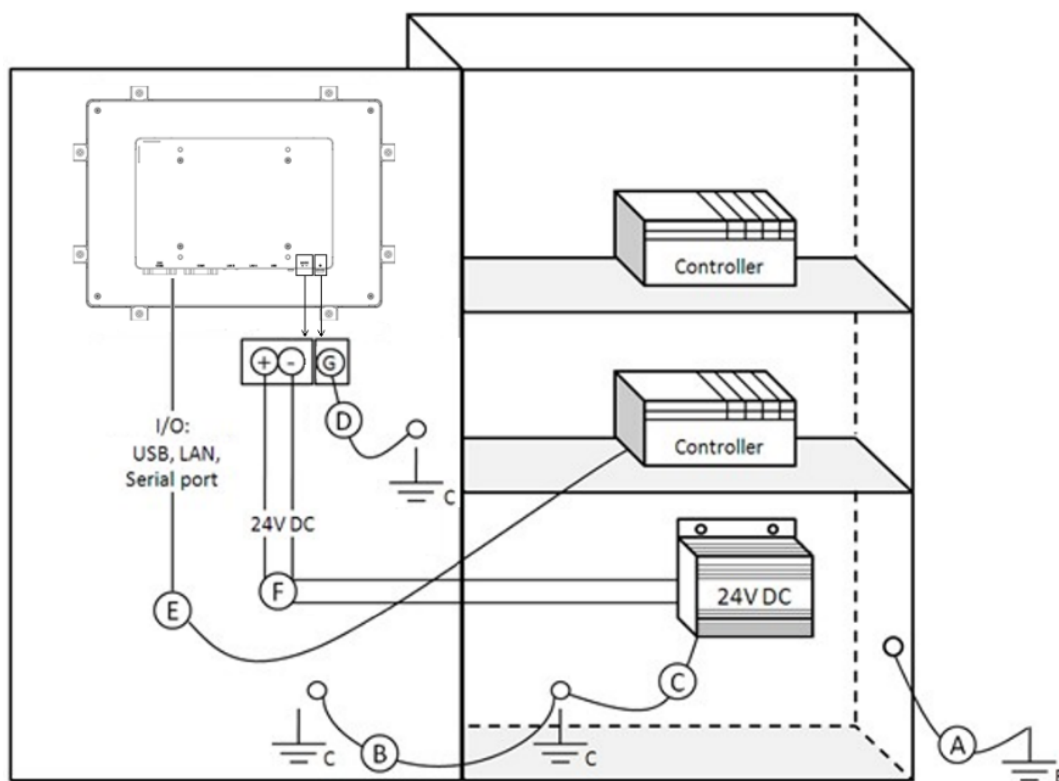

A: Connect the cabinet to earth ground.

B: Ensure that all cabinet has been grounded together.

C: Connect the ground of the power supply to the cabinet.

D: Connect the ground pin of TPC-100W system to the cabinet.

E: Connect the I/O to the controller if needed.

F: Connect the V+ and V- of power supply to TPC-100W system.

Power should only be supplied after the wiring A-F have been performed.

**Caution!** *Ensure that all wires follow the installation guidelines or damage to the system may occur.*



*Assurez-vous que tous les fils suivent les directives d'installation ou qu'ils sont endommagés. système peut se produire.*



# Chapter 3

Linux Yocto

---

## 3.1 ARM Yocto 3.0

TPC-100W platform is an embedded system with Linux Yocto 3.0. It contains system-required commands and drivers ready.

The Yocto Project is an open source collaboration project that helps developers create custom Linux-based systems that are designed for embedded products regardless of the product's hardware architecture. Yocto Project provides a flexible toolset and a development environment that allows embedded device developers across the world to collaborate through shared technologies, software stacks, configurations, and best practices used to create these tailored Linux images.

## 3.2 ARM Yocto 3.0 Software Support

### 3.2.1 System Default Software

ARM Yocto 3.0 support complete IIoT function as default including:

- SSH
- Wayland Terminal
- Qt5.15.0
- Gstreamer1.0
- Imx-gpu-viv 6.4.3.p1.4
- Wayland 1.18.0-r0
- Weston 9.0.0.imx-r0
- Weston-xwayland 9.0.0.imx-r0
- VNC
- TPM SLB9670
- GUI Settings Tool
- Recovery
- Security boot

### 3.2.2 GPU Accelerations

Vivante GPU accelerations for Wayland; The Hantro Video Processing Unit supports the following decoders:

- video/x-h265
- video/x-vp9
- video/x-h264
- video/x-vp8
- video/x-vp6-flash
- video/mpeg
- video/x-h263
- video/x-flash-video
- video/x-divx
- video/x-xvid
- video/x-cavs
- video/x-wmv
- video/x-pn-realvideo
- video/x-raw



### 3.2.3 Install Yocto 3.0 Software

Firstly, burning image to microSD card and instruction as below. If you already have the microSD card with Yocto image, you can go to the second part directly.

- Note!**  1. Recommend th storage device is more than 16GB storage interface( ex: MicroSD) to avoid not enough storage space.
2. Depend on Hardware limited, won't wake up after click GUI suspend button.
3. Not support software install online through apt-get command.
4. Not support mount USB storage for NTFS format.
5. Recommended used command sync to ensure data is written and sync to the hard drive, prevented power supply cut-off cause data lost.

If your PC is Linux environment:

1. Prepare the Linux environment that can use “uncompress” and “dd” command. (Below uses ubuntu 18.04 as example.)
2. Use “tar Jxvf filename” to uncompress the file to img format. If your file has already been img format, please go to next step directly.

```
$ tar Jxvf eamb9918-sdcard_1.1.0.img.tar.xz
```

3. Use “sudo dd if=imgfile of=SDpartition bs=4096” to burn the img file to your microSD card. (Note: You should check which partition is your microSD card firstly and you can format your microSD card before this step to avoid compatibility issue.)

```
$ sudo dd if=eamb9918-sdcard_1.1.0.img of=/dev/sdc bs=4096
```

If your PC is Windows:

1. Unzip the file to img format.
2. Use the Rufus or Raspberry Pi Imager provided by Raspberry Pi to burn the img file to your microSD card. You can refer to below link for the usage of the tools.  
Raspberry Pi Imager:  
<https://www.raspberrypi.com/news/raspberrypi-imager-imaging-utility/>  
Rufus:  
<https://rufus.ie/en/>

Second, after image is put into microSD card, use microSD card to update the image.

1. Remove the screws from back cover. Due to COM port cover need to put down, then slide up.

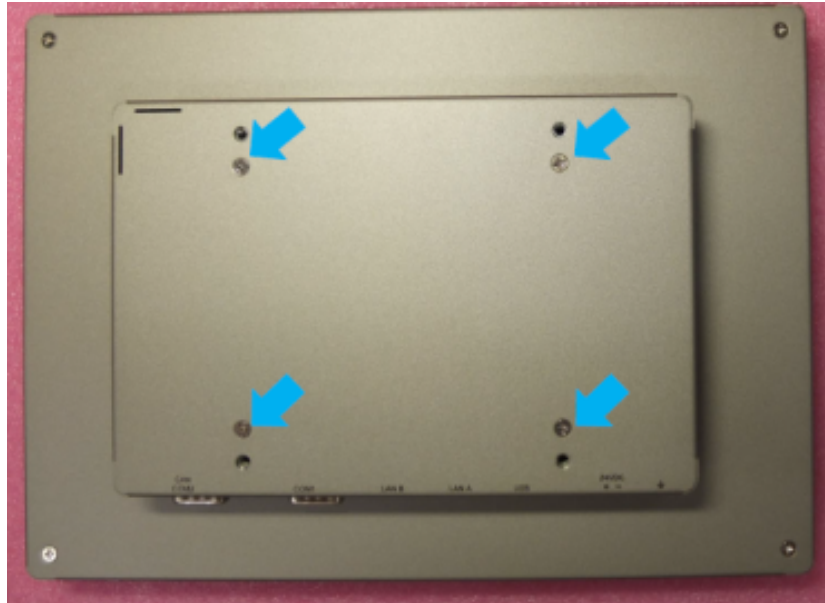

2. Insert microSD card, then adjust switch as below order (red remark).

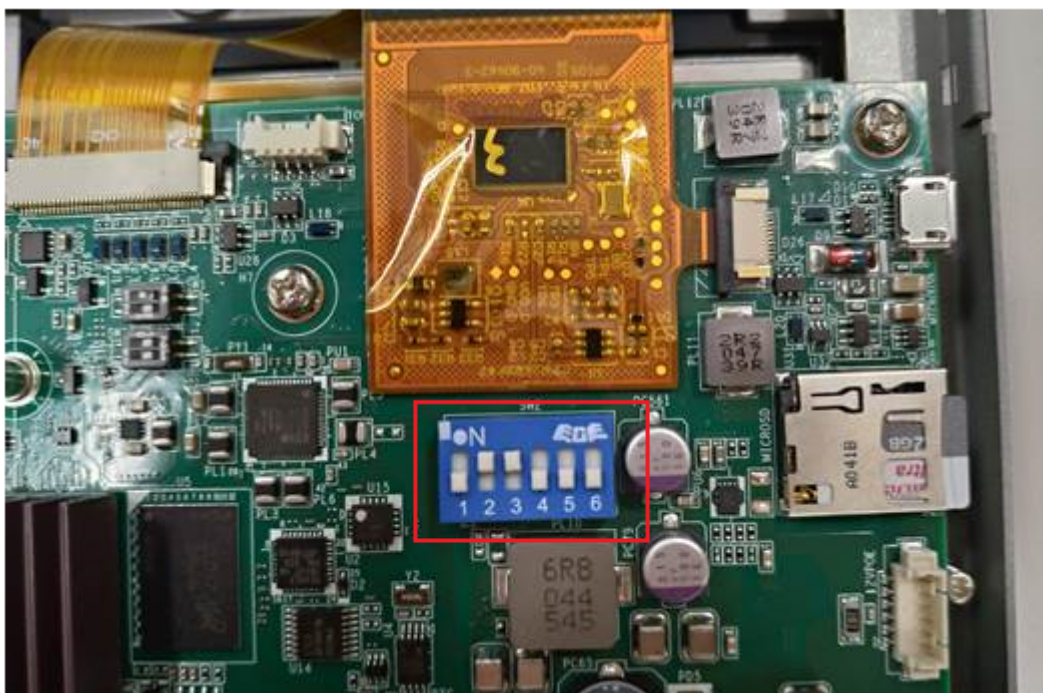

3. Power on the system and open Terminal. Then input below commands.

```
sh-5.0# cd /mk_inand/scripts  
sh-5.0# ./mkinand-linux.sh /dev/mmcblk2
```

```
Wayland Terminal  
sh-5.0# cd /mk_inand/scripts/  
sh-5.0# ls  
mkinand-linux.sh  mkspi-advboot.sh  
sh-5.0# ./mkinand-linux.sh /dev/mmcblk2
```

4. Waiting for update is finished. Then power off the system.
5. Adjust switch as below location, remove microSD card.



6. Power on again from eMMC.

### 3.2.4 First Login

If you are the first time to login the system, it will ask you to setup the password. Please connect the physical keyboard and use the account “root” to login. Then you have to input the password you want to use 2 times and reboot the system. Now you can use the Yocto system with GUI.

```
NXP i.MX Release Distro 5.4-zeus eamb9918 tty1
eamb9918 login: root
You are required to change your password immediately (administrator enforced)
New password:
Retype new password:
root@eamb9918:~# reboot_
```

## 3.3 TPC-100W Module Extension

TPC-100W supports one M.2 E-Key slot which allows users to expand the functionality. There are pre-configured Wi-Fi modules ready to use. This chapter will take Wi-Fi module as an example to demonstrate how to use a module on TPC-100W.

### 3.3.1 Module Information

P/N: 968DD00086

M.2 2230 RYWDB02 802.11a/b/g/n+BT5

Cable: 17cm~20cm

### 3.3.2 The Configuration and Connection of WIFI Module

Configure by Command mode

1. Check the WIFI device exists.

```
1 $ ifconfig wifi
2 wifi0      Link encap:Ethernet  HWaddr 88:da:1a:76:38:bc
3           inet6 addr: fe80::8ada:1aff:fe76:38bc/64 Scope:Link
4           UP BROADCAST MULTICAST DYNAMIC MTU:1500 Metric:1
5           RX packets:0 errors:0 dropped:0 overruns:0 frame:0
6           TX packets:0 errors:0 dropped:0 overruns:0 carrier:0
7           collisions:0 txqueuelen:1000
8           RX bytes:0 (0.0 B)  TX bytes:0 (0.0 B)
```

Or you can use below command to check.

```
1 ls /sys/class/net/
2 can0 can1 eth0 eth1lo wifi0
```

If the WIFI node exists, the WIFI driver works normally.



## 2. Enable WIFI.

```
1 $ connmanctl technologies
2 /net/connman/technology/p2p
3   Name = P2P
4   Type = p2p
5   Powered = False
6   Connected = False
7   Tethering = False
8 /net/connman/technology/wifi
9   Name = WiFi
10  Type = wifi
11  Powered = True
12  Connected = False
13  Tethering = False
14 /net/connman/technology/bluetooth
15  Name = Bluetooth
16  Type = bluetooth
17  Powered = True
18  Connected = False
19  Tethering = False
20 /net/connman/technology/ethernet
21  Name = Wired
22  Type = ethernet
23  Powered = True
24  Connected = True
25  Tethering = False
```

If “Powered = True”, it means WIFI is enabled.

If WIFI is disabled, please use below command to enable it.

```
1 $ connmanctl enable wifi
```

### 3. Scanning WIFI hotspot.

```

1 $ connmanctl scan wifi
2 $ connmanctl services
3 *AO Wired          ethernet_c400ad7d091c_cable
4   advanxxx        wifi_88dala7638bc_616476616e74656368_managed_psk
5   TP-LINK_A990    wifi_88dala7638bc_54502d4c494e4b5f41393930_managed_psk
6   QA-Test         wifi_88dala7638bc_51412d54657374_managed_psk
7   TP-LINK_603854  wifi_88dala7638bc_54502d4c494e4b5f363033383534_managed_none
8   PCCWS_LOCAL    wifi_88dala7638bc_50434357535f4c4f43414c_managed_psk
9   QA-Test-5G     wifi_88dala7638bc_51412d546573742d3547_managed_psk
10  php             wifi_88dala7638bc_706870_managed_psk
11                wifi_88dala7638bc_hidden_managed_none
12                wifi_88dala7638bc_hidden_managed_psk
13  KOALXA-AP-2.4   wifi_88dala7638bc_4b4f414c58412d41502d322e34_managed_psk
14  PCCWS_GDCN     wifi_88dala7638bc_50434357535f47444434e_managed_psk
15  ChinaNet-APUU  wifi_88dala7638bc_4368696e614e65742d41505555_managed_psk
16  DIRECT-8CAXA-JIANFENGmsMZ wifi_88dala7638bc_4449524543542d38434158412d4
17                a49414e46454e476d734d5a_managed_psk
18  HP-HOTSPOT-98-LaserJet M1218 wifi_88dala7638bc_48502d484f5453504f542d39382d4c
19                617365724a6574204d31323138_managed_none
20  KoalXARd@6     wifi_88dala7638bc_4b6f616c584152644036_managed_psk
   TP-LINK_F8FE    wifi_88dala7638bc_54502d4c494e4b5f46384645_managed_none
   KOALXA-AP-5    wifi_88dala7638bc_4b4f414c58412d41502d35_managed_psk

```

### 4. Connect to WIFI hotspot.

If the WIFI hotspot needs password, it will remind you to input.

```

1 connmanctl
2 connmanctl> agent on
3 Agent registered
4 connmanctl> connect wifi_88dala7638bc_616476616e74656368_managed_psk
5 Agent RequestInput wifi_88dala7638bc_616476616e74656368_managed_psk
6   Passphrase = [ Type=psk, Requirement=mandatory ]
7 Passphrase? *****
8 Connected wifi_88dala7638bc_616476616e74656368_managed_psk
9 connmanctl> quit

```

### 5. Now you can browse the internet by WIFI.

### 3.3.3 The Configuration and Connection of Bluetooth Module

Configure by Command mode

1. Check the Bluetooth device status.

```
1 root@Qing:~# hciconfig
2 hci0:   Type: BR/EDR   Bus: USB
3 BD Address: 00:1A:7D:DA:71:13  ACL MTU: 310:10  SCO MTU: 64:8
4 UP RUNNING
5 RX bytes:574 acl:0 sco:0 events:30 errors:0
6 TX bytes:368 acl:0 sco:0 commands:30 errors:0
```

If there is no device showed, it means no driver or device.

2. Enable Bluetooth service.

```
1 systemctl status bluetooth
2 ## 如果没有active, 你需要执行以下指令, 否则, 无须执行
3 systemctl enable bluetooth.service
4 systemctl start bluetooth
```

```
1 connmanctl enable bluetooth
2 #or
3 # hciconfig hci0 up
```

3. Open Bluetooth.

```
1 bluetoothctl
2
3     [bluetooth]# power on
4     [bluetooth]# pairable on
```

4. Scanning Bluetooth device.

Start scanning:

```
1     ## 扫描设备
2     [bluetooth]# scan on
3 Discovery started
4 [CHG] Controller 00:19:88:5E:10:B1 Discovering: yes
5 [NEW] Device 98:39:8E:1B:D8:88 Galaxy A5 (2016)
6 [CHG] Device 98:39:8E:1B:D8:88 RSSI: -86
7 Now, Copy the MAC Address of your PC
```

Stop scanning:

```
1 ## 结束扫描
2 [bluetooth]# scan off
```

Please record the MAC address you want to connect.



## 5. Pair and connect to the Bluetooth device.

Pair the device by MAC address. If the device is paired before, you can ignore this.

```
1 [bluetooth]# pair 98:39:8E:1B:D8:88
2 Attempting to pair with 98:39:8E:1B:D8:88
3 [CHG] Device 98:39:8E:1B:D8:88 Connected: yes
4 Request confirmation
5 [agent] Confirm passkey 117022 (yes/no):
```

Connect the device by MAC address.

```
1 [bluetooth]# connect 98:39:8E:1B:D8:88
2 Attempting to connect to 98:39:8E:1B:D8:88
3 [CHG] Device 98:39:8E:1B:D8:88 Connected: yes
4 Connection successful
5 [CHG] Device 98:39:8E:1B:D8:88 ServicesResolved: yes
```

Trust the device by MAC address.

```
1 [bluetooth]# trust 98:39:8E:1B:D8:88
```

Now the connection is successful. You can exit the bluetoothctl.

```
1 [bluetooth]# quit
```

## 6. Using Obex profile to test the file transmission by Bluetooth.

```
1 $ echo "helloworld" > /home/root/test.txt
2 $ export $(dbus-launch)
3 $ /usr/libexec/bluetooth/obexd -r /home/root -a -d &
```

```
1 obexctl
2 [obex]# connect 98:39:8E:1B:D8:88
3 [obex]# send <file>
4 [obex]# quit
```

---

## 3.4 Time and Date Setting

Set system time (2021/10/07 09:00:00):

```
sh-5.0# date -s "2021/10/07 09:00:00"
```

Synchronize time from the NTP server:

```
sh-5.0# ntpdate <NTPSERVERIP>
```

Reset RTC hardware clock time (use current system time):

```
sh-5.0# hwclock -w
```

Reset system time (use RTC hardware clock time):

```
sh-5.0# hwclock -s
```

Set system time zone (use Taipei time):

```
sh-5.0# cp /usr/share/zoneinfo/Asia/Taipei /etc/localtime  
sh-5.0# sync
```

## 3.5 CAN Setting

TPC-100W support FINTEK CAN. The below table shows the detailed information of CAN on TPC-100W and here we list the basic command to use CAN on TPC-100W.

HW	DEVICE	MODE
Fintek CAN0	can0	socket can

Setting: Open CAN device (The following examples will configure “can0” to bit-rate 250000, sample-point 0.875 and error restart with 100ms.)

```
sh-5.0# ifconfig can0 down
sh-5.0# ip link set can0 type can restart-ms 100
sh-5.0# ip link set can0 type can bitrate 250000 sample-point 0.875
sh-5.0# ip link set can0 type can berr-reporting on
sh-5.0# ifconfig can0 txqueuelen 1000
sh-5.0# ifconfig can0 up
```

We'll use “candump” to receive data, “cangen” & “cansend” to send data. The “cangen” will send random data & ID and “cansend” will send specific data & ID to CAN-BUS.

Send message (“123#R”) to can0:

```
sh-5.0# cansend can0 123#R
```

Receive message from can0:

```
sh-5.0# candump can0
```

## 3.6 Brightness Setting

1. Get brightness value:

```
sh-5.0# cat /sys/class/backlight/lvds_backlight/@0/brightness
```

2. Set brightness value: You can set the value from 0~100. Please notice that value 0 will let the screen be black.

```
Value 1
sh-5.0# echo 1 >> /sys/class/backlight/lvds_backlight/@0/brightness
Value 100
sh-5.0# echo 100 >> /sys/class/backlight/lvds_backlight/@0/brightness
```

## 3.7 COM Setting

TPC-100W supports 2 COM port. One is RS232/422/485 and another is RS485.

Set com0 as RS232 mode and baud rate 115200.

```
sh-5.0# echo out > /sys/class/gpio/gpio85/direction
sh-5.0# echo out > /sys/class/gpio/gpio86/direction
sh-5.0# echo 1 > /sys/class/gpio/gpio85/value
sh-5.0# echo 0 > /sys/class/gpio/gpio86/value
sh-5.0# stty -F /dev/ttymx0 -echo -onlcr 115200
```

Set com0 as RS422 mode and baud rate 115200.

```
sh-5.0# echo out > /sys/class/gpio/gpio85/direction
sh-5.0# echo out > /sys/class/gpio/gpio86/direction
sh-5.0# echo 1 > /sys/class/gpio/gpio85/value
sh-5.0# echo 1 > /sys/class/gpio/gpio86/value
sh-5.0# stty -F /dev/ttymx0 -echo -onlcr 115200
```

Set com0 as RS485 mode and baud rate 115200.

```
sh-5.0# echo out > /sys/class/gpio/gpio85/direction
sh-5.0# echo out > /sys/class/gpio/gpio86/direction
sh-5.0# echo 0 > /sys/class/gpio/gpio85/value
sh-5.0# echo 1 > /sys/class/gpio/gpio86/value
sh-5.0# stty -F /dev/ttymx0 -echo -onlcr 115200
```

## 3.8 Firewall Setting

Linux Yocto image for TPC-100W enable 22 SSH, 80 HTTP, 443 HTTPS, 8080 SWUPDATE by default for usage. You can follow below command to change it.

1. Check the list of iptables.

```
sh-5.0# iptables -L
```

2. Modify the /etc/iptables/iptables.rules and reboot the system.

```
# Generated by iptables-save v1.8.3 on Wed Feb 23 10:16:51 2022
*filter
:INPUT DROP [3652:224108]
:FORWARD ACCEPT [0:0]
:OUTPUT ACCEPT [8:1414]
-A INPUT -i lo -j ACCEPT
-A INPUT -m state --state RELATED,ESTABLISHED -j ACCEPT
-A INPUT -p tcp -m state --state NEW -m tcp --dport 22 -j ACCEPT
-A INPUT -p tcp -m state --state NEW -m tcp --dport 80 -j ACCEPT
-A INPUT -p tcp -m state --state NEW -m tcp --dport 443 -j ACCEPT
-A INPUT -p tcp -m state --state NEW -m tcp --dport 8080 -j ACCEPT
-A INPUT -p icmp -m icmp --icmp-type 8 -j ACCEPT
COMMIT
# Completed on Wed Feb 23 10:16:51 2022
```

## 3.9 Recovery

Do recovery on TPC-100W

1. Check release version

```
sh-5.0# cat /etc/os-release
```

2. Set environment.

If you have installed the old system (the version is less than eamb9918-sdcard\_1.0.0.img), you need to connect debug port and enter any key to stop uboot boot process to set the following command.

```
#env default -a
#saveenv
#reset
```

3. Local recovery mode.

If you want to enter local recovery mode, download the file from Advantech website, then copy file to /userdata.

```
cd /userdata
$ swupdate --update -g -i /userdata/swupdate-image_1.0.swu --reboot
```

After the automatic reboot, the operation of recovery will be performed automatically.

Note: Switch to normal boot if the update is interrupted and cannot boot normally.

You need to connect debug port and enter any key to stop uboot boot process to set the following command.

```
$ env set recovery_status
$ saveenv
$ reset
```

Then the system will reboot.

## 3.10 GUI Settings Tool

Advantech TPC-100W Settings Tool is a Linux-based utility. Settings Tool helps user to get image version, get/set network configuration, get/set time configuration, get/set screen configuration, set startup configuration, set VNC configuration and Set update/recovery configuration. For more information, you can refer to TPC-100W\_Settings\_Tool\_User\_Guide.pdf.

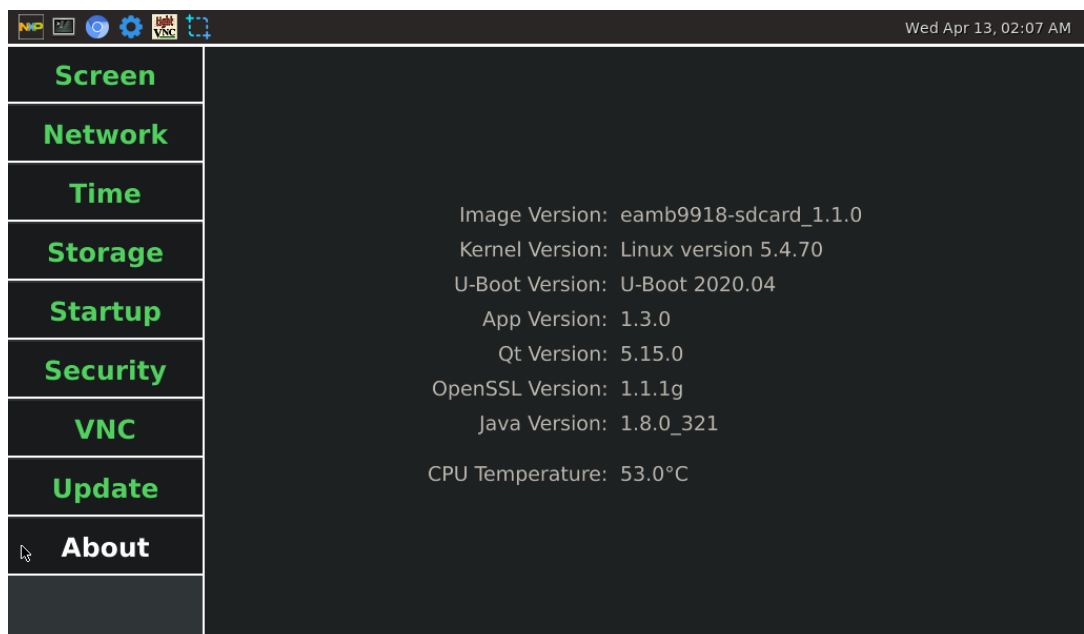

## 3.11 Weston Keyboard Shortcuts

The table below lists the actions that can be performed through Weston keyboard shortcuts, when the TPC-100W is connected to a keyboard.

"super", i.e. Windows key between "ctrl" and "alt" (default value)

Command	Action	Condition(s)
ctrl + scroll	Zoom in/out the desktop	Keyboard + mouse
super + shift + f	Put activated window fullscreen	Keyboard
super + left mouse button	Move activated window	Keyboard + mouse
super + middle mouse button	Rotate activated window	Keyboard + mouse
super + right mouse button	Resize activated window	Keyboard + mouse
super + shift + left mouse button	Resize activated window	Keyboard + mouse
super + tab	Switch windows	Keyboard
super + k	Kill activated window	Keyboard
super + s	Capture a screenshot (see details below)	Keyboard

### ■ Capture a screenshot

Refer to the table above for the command to be used. The captured picture (PNG format) is automatically stored in `/wayland-screenshot-2022-03-08_01-48-19.png`.





# Chapter 4

Android

## 4.1 Android 10

TPC-100W platform is an embedded system with Android 10. It contains system-required commands and drivers ready.

AIM-Android10 is developed for Advantech devices based on formal Android10. It is customized to satisfy users' requirements and to add new functions and features.

## 4.2 Android 10 Software Support

### 4.2.1 System Default Software

AIM-Android10 support below functions as default including:

- Chromium
- ADB debugging support
- Demo serial port utility
- Kiosk Setting
- Android agent (Device manager)

### 4.2.2 Other Applications

Many other applications for arm supported by Android or other resource web sites. You can search and download them from internet by yourself.

## 4.3 Install Android Software

TPC-100W supports boot from SD card or onboard flash. This section will guide you how to build an image for TPC-100W Android system boot media.

### 4.3.1 Create a Bootable SD Card

Please follow the steps below to create an SD card (not less than 8G) for boot up. (Note: The PC's free partition needs 10G or more)

If your PC is Linux environment:

1. Prepare the Linux environment that can use "uncompress" and "dd" command. Below uses ubuntu as example.
2. Copy "AIM-Android-10-ARM\_64-TPC-1XX\_yyyy\_mm\_dd.zip" package to your PC /root/.
3. Insert one SD card into your PC and open "Terminal".

```
$sudo su
```

Input your password.

```
# cd /root/  
# unzip AIM-Android-10-ARM_64-TPC-1XX_yyyy_mm_dd.zip
```

Check the SD card location, like/dev/sdb

```
#dd                if=/root/AIM-Android-10-ARM_64-TPC-1XX_yyyy_mm_dd/eamb9918-
sdcard_xxxxxxxx.img of=/dev/sdb bs=4096
#sync
#eject /dev/sdb
```

4. Then insert the SD card to TPC-100W and power up. Now, it should boot up with an Ubuntu environment.

If your PC is Windows 10:

1. Unzip the AIM-Android-10-ARM\_64-TPC-1XX\_yyyy\_mm\_dd.zip. (Note: The PC's free partition need 10G or more)
2. Use the rufus to burn the image.

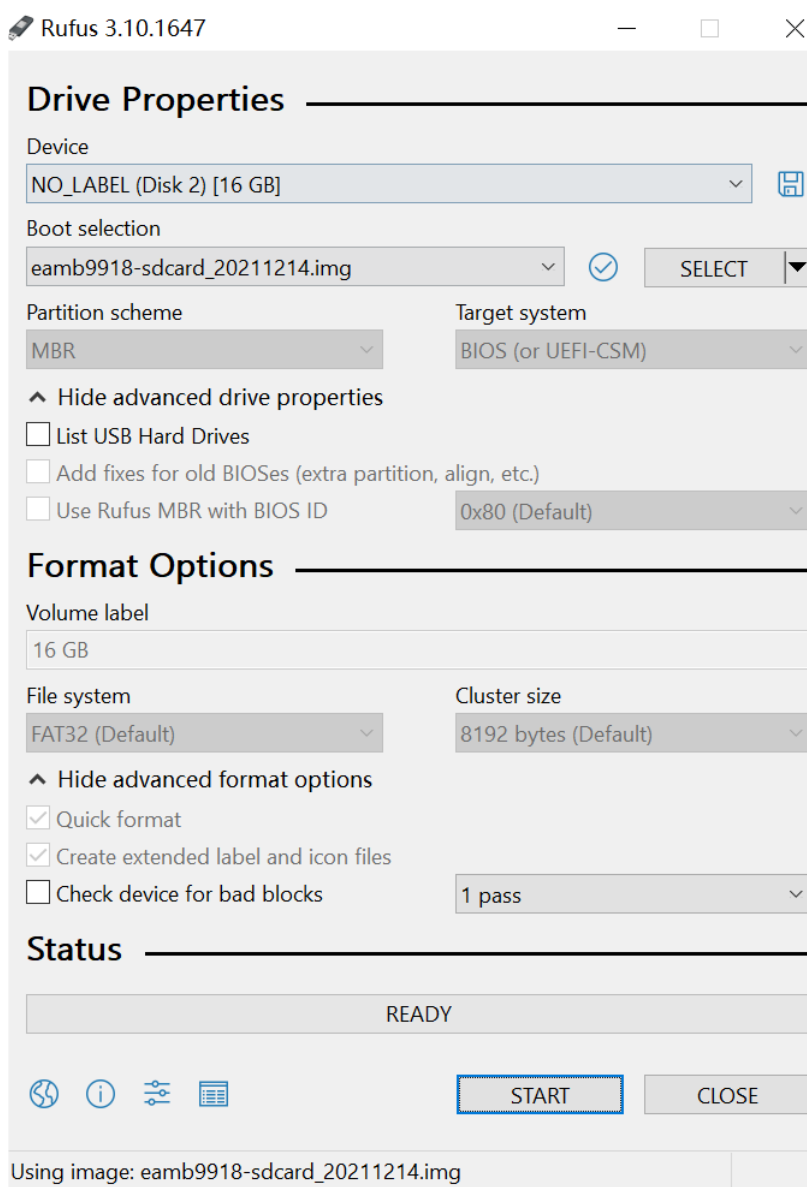

3. Then insert the SD card to TPC-100W and power up. Now, it should boot up with an Ubuntu environment.

No matter you create SD card in Linux environment or Windows 10, you have to do below setting.

1. The DIP switch(SW2)needs to be adjusted to“1-off 2-on 3-on 4-off 5-off 6-off”.
2. You need to connect debug port and enter any key to stop uboot boot process to set the following command.

```
#env default -a
#setenv lvds_panel_mode 0
#saveenv
#reset
```

- 0: is for 1024x600
- 1: is for 1280x800
- 2: is for 1366x768
- 3: is for 1920x1080

### 4.3.2 Boot from eMMC

The TPC-100W Android image is in the SD card you create. (/root/AndroidImg).

1. Boot from SD card you create.
2. Perform the following command:

```
$sudo su
#cd /root/AndroidImg
#./burnEmmc.sh/dev/mmcblk2
```

3. Please power off and remove the SD card.
4. The DIP switch(SW2)needs to be adjusted to“1-on 2-off 3-off 4-off 5-off 6-off”.
5. You need to connect debug port and enter any key to stop uboot boot process to set the following command.

```
#env default -a
#setenv lvds_panel_mode 0
#saveenv
#reset
```

- 0: is for 1024x600
- 1: is for 1280x800
- 2: is for 1366x768
- 3: is for 1920x1080

6. Waiting for the LCD interface to have a screen output (for the first time, the eMMC needs about 65s). Do not shut down during the waiting process, unplug the SD card, unplug the monitor or run the system command through the console, otherwise the system may crash.

## 4.4 Serial Port Sample

After installing AIM-Android, you will see a Serial application in App list. Users can test serial port with it.

1. Choose the serial port mode.  
Settings → Network & internet → Select serial mode (com1)
  - 232\_mode
  - 422\_mode
  - 485\_mode
2. Start the application.

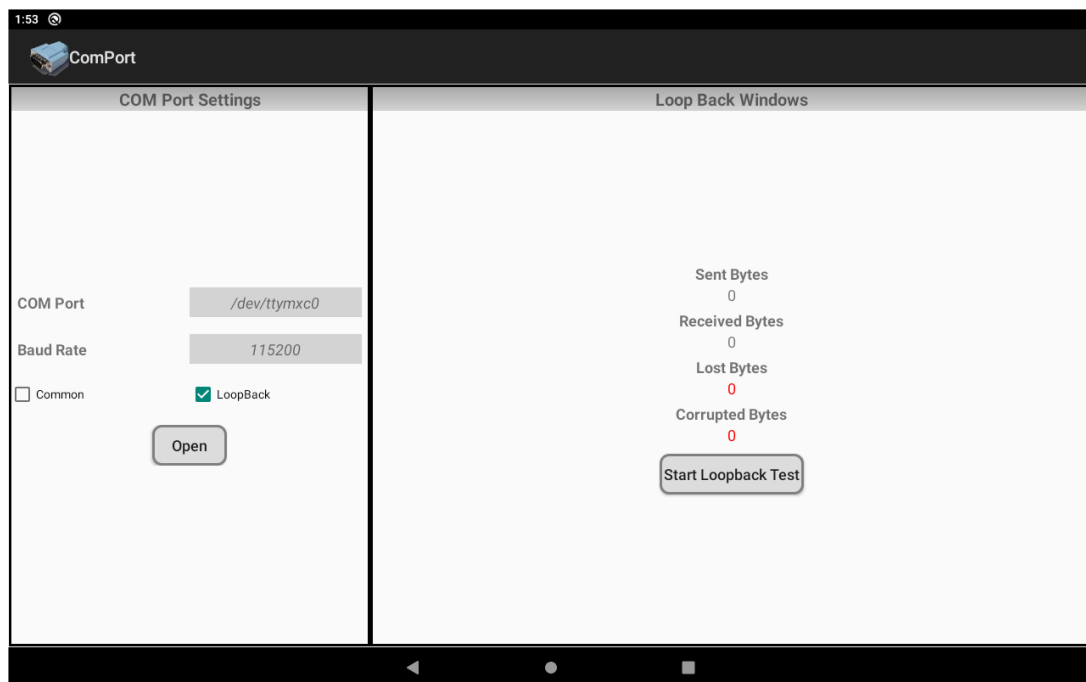

The COM1(/dev/ttymx0) support three modes:232mode,422mode,485mode.  
The COM2(/dev/ttymx2) only support 485mode.

## 4.5 Kiosk Setting

For Android Kiosk solution, Advantech provide a Kiosk Setting launch app, user can use this app to set any other android app as kiosk app. Kiosk app means it will run in full screen when boot up, navigate bar and status bar of android will hide.

### 4.5.1 Set the Kiosk Setting App as the Default Launcher

Just launch the Kiosk Setting app, the app can be the android default home app.

When Kiosk Setting app starts for the first time, you can see the following screen. Please set the password of kiosk mode according to the prompt information in the dialog box.

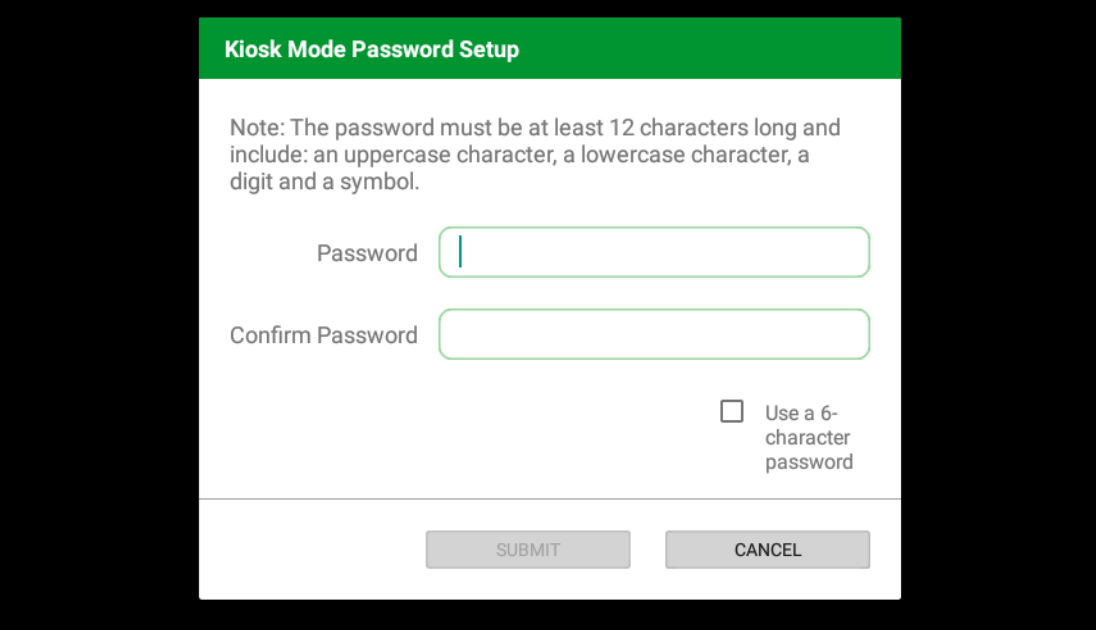

The screenshot shows a dialog box titled "Kiosk Mode Password Setup" with a green header. Below the title, there is a note: "Note: The password must be at least 12 characters long and include: an uppercase character, a lowercase character, a digit and a symbol." There are two input fields: "Password" and "Confirm Password". To the right of the "Confirm Password" field, there is a checkbox labeled "Use a 6-character password". At the bottom of the dialog, there are two buttons: "SUBMIT" and "CANCEL".

After input, click "SUBMIT" button to enter the app main interface.

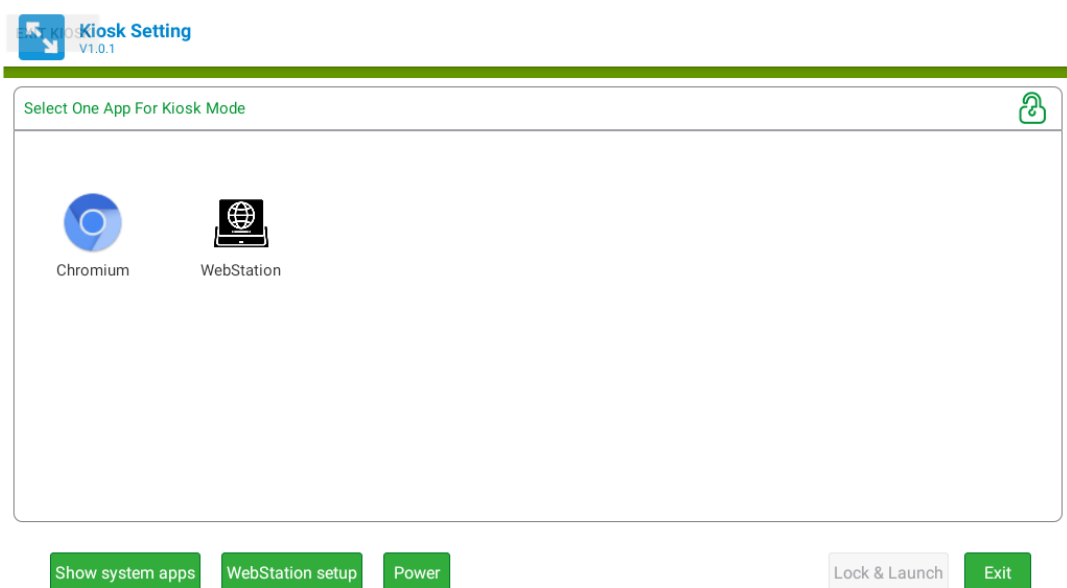

## 4.5.2 Set App as Kiosk App

First, click the "Chromium" icon in the main interface, and then click the "lock & launch" button to set the Chromium app as kiosk app.

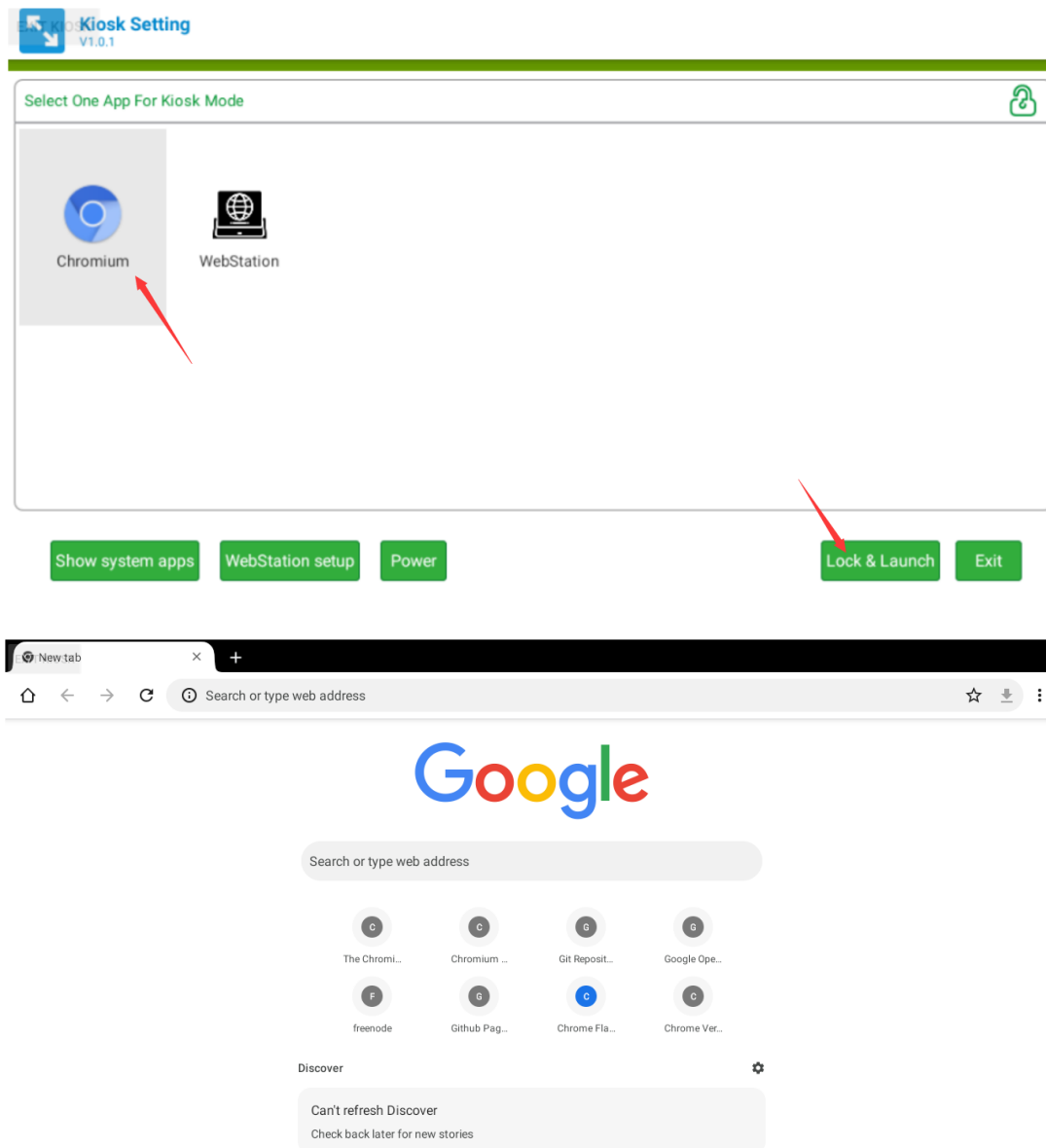

### 4.5.3 Exit Kiosk App

If you want to exit the kiosk app, you need to long press the “EXIT KIOSK” on the screen and enter the password for setting the kiosk mode before.

After long pressing the “EXIT KIOSK” on the screen, the following dialog box will appear to ask for the password. After entering the password, click "CONTINUE" button to return to the Kiosk Setting app interface.

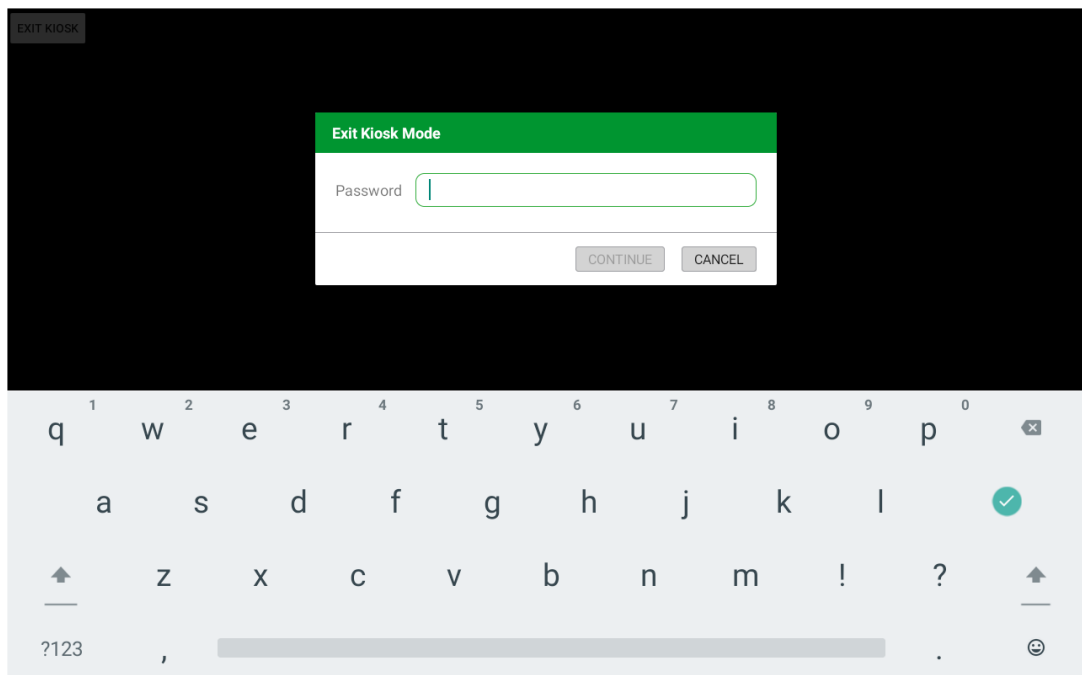
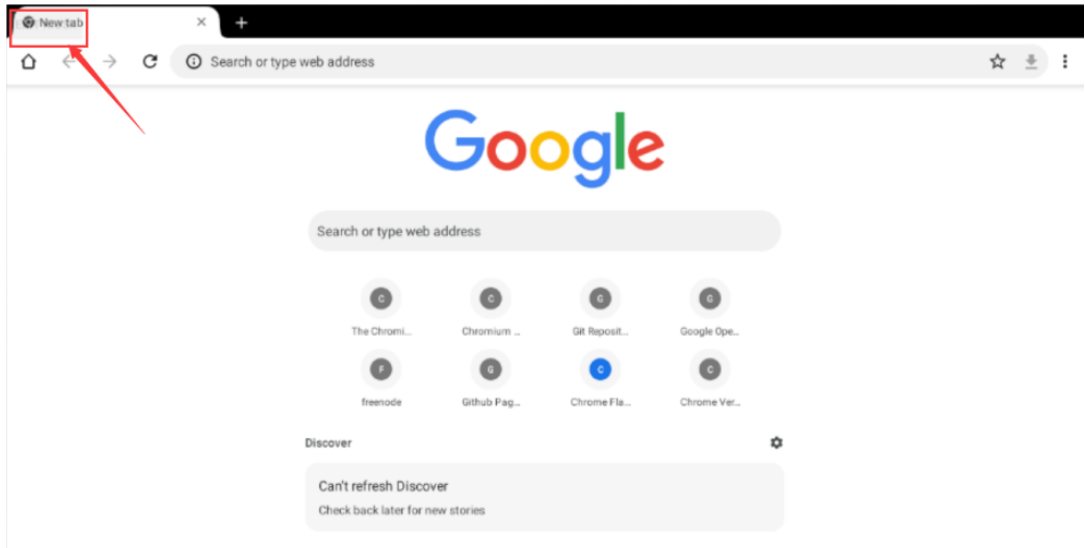



#### 4.5.4 Set WebView as Kiosk App

Click the "WebStation setup" and input the URL.

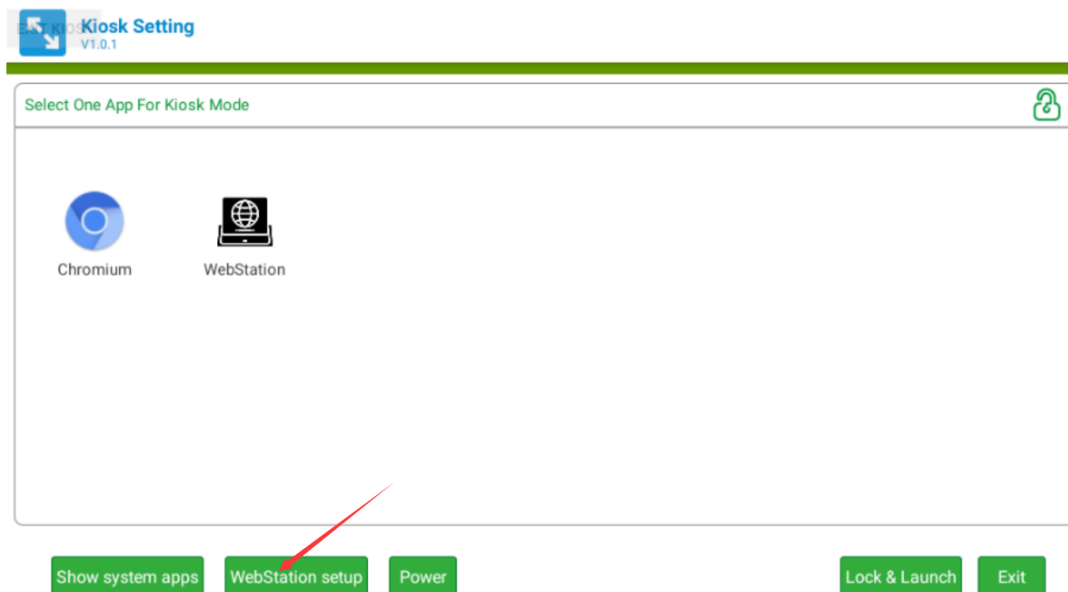

Click the "WebStation" icon in the main interface, and then click the "lock & launch" button to set the Chromium app as kiosk app.

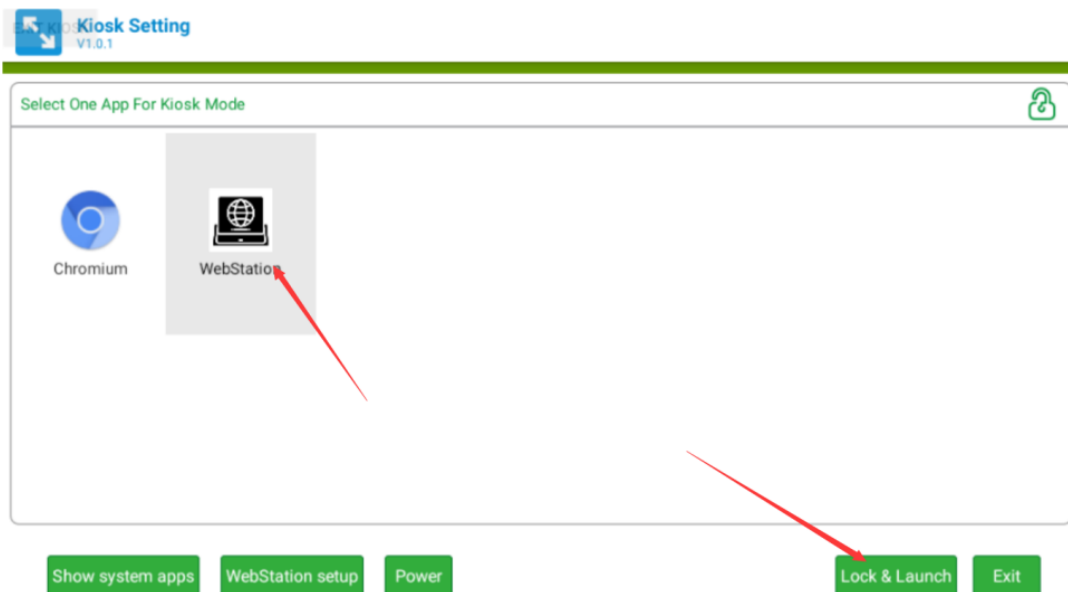

## 4.5.5 Show System App

Click the "Show system apps" icon in the main interface.

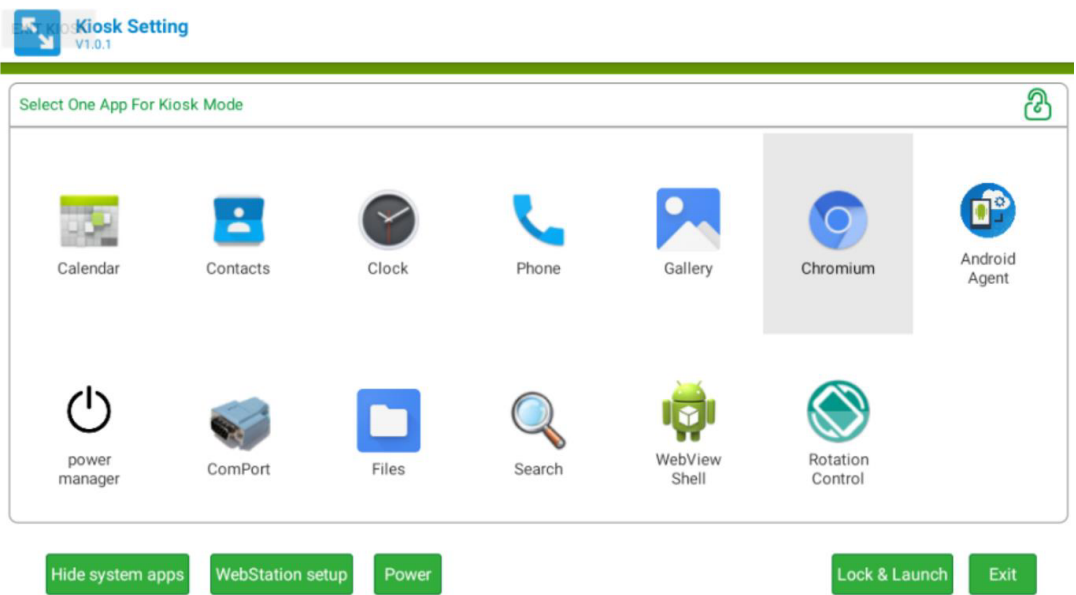
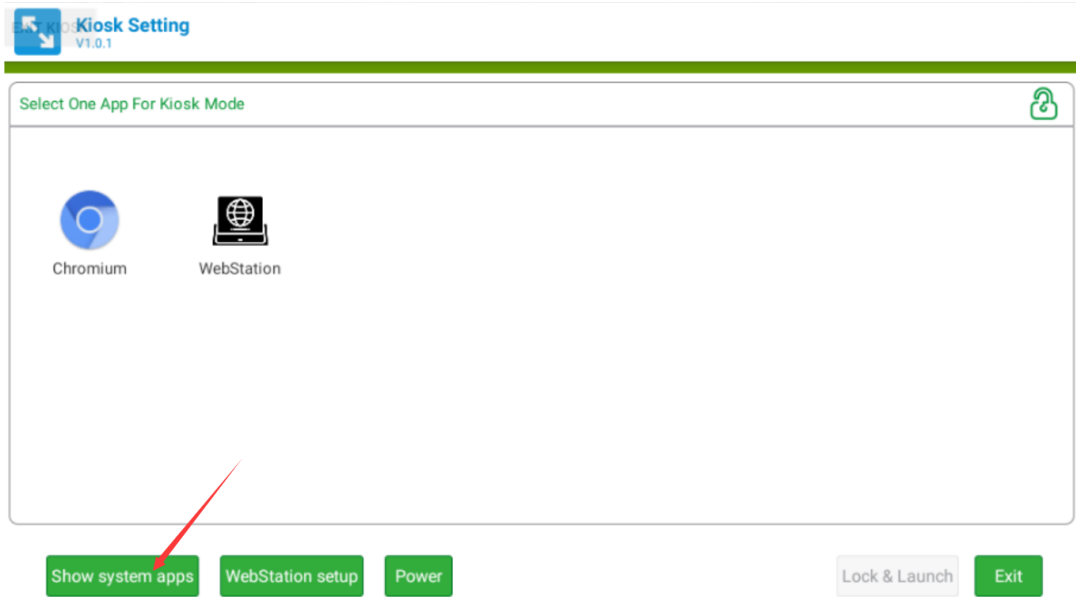

## 4.5.6 Exit Kiosk Setting

Click the "Exit" in the main interface and input the password.

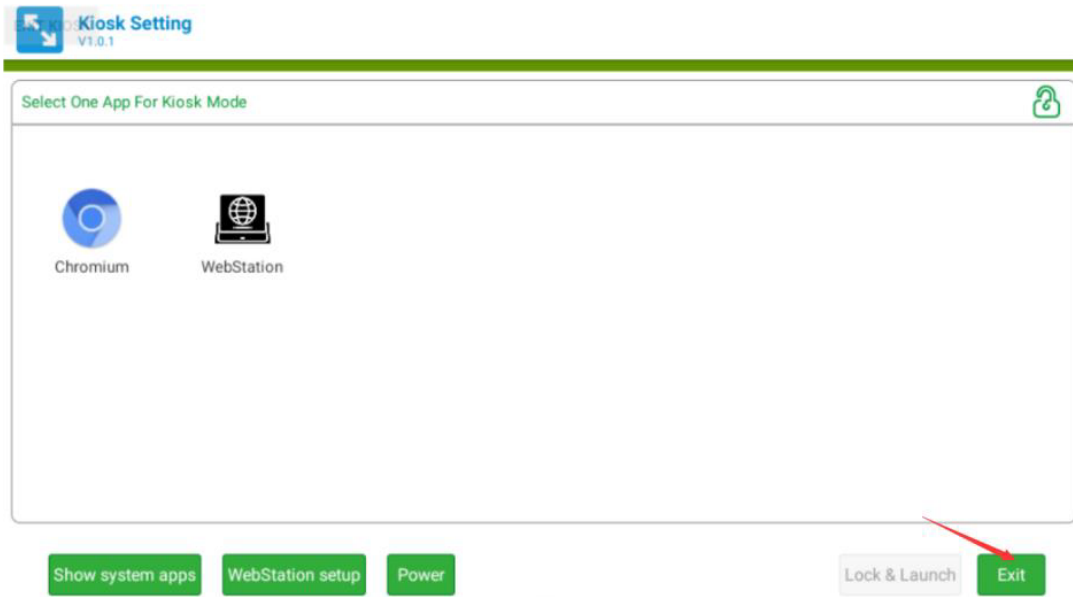



# Appendix **A**

## Pin Assignments

## A.1 M.2 Slot (E-Key)

- 8.5mm half size 75 Pin M.2 slot (E-Key)

Pin	Signal	Description	Pin	Signal	Description
1	GND		2	+3.3V	
3	USB+	USB serial data inter- face compliant to the USB 2.0 speci- fication	4	+3.3V	
5	USB-		6	Reserved	NC
7	GND	Secure Digital Input Output, a type of Secure Digital card interface. It can be used as an interface for input or output devices.	8	PCM_BCLK	PCM is another 4 wire interface, very similar to I2S, which can sup- port a more flexible protocol. It has bit clock (BCLK) and sync (SYNC) lines that are used to syn- chronise the link while the Tx and Rx lines are used to transmit and receive the audio data.
9	SDIO_CLK		10	PCM_SYNC	
11	SDIO_CMD		12	PCM_OUT	
13	SDIO_DATA0		14	PCM_IN	
15	SDIO_DATA1		16	Reserved	NC
17	SDIO_DATA2		18	GND	
19	SDIO_DATA3		20	Reserved	NC
21	SDIO_WAKE#		22	Reserved	NC
23	SDIO_RESET#				
33	GND			32	Reserved
35	Reserved	NC	34	Reserved	NC
37	Reserved	NC	36	Reserved	NC
39	GND		38	Reserved	NC
41	Reserved	NC	40	Reserved	NC
43	Reserved	NC	42	Reserved	NC
45	GND		44	Reserved	NC
47	Reserved	NC	46	Reserved	NC
49	Reserved	NC	48	Reserved	NC
51	GND		50	SYSCLK	
53	Reserved	NC	52	RESET#	Functional reset to the card
55	Reserved	NC	54	Reserved	NC
57	GND		56	Reserved	NC
59	Reserved	NC	58	I2C_DATA	
61	Reserved	NC	60	I2C_CLK	
63	GND		62	Reserved	NC
65	Reserved	NC	64	Reserved	NC
67	Reserved	NC	66	Reserved	NC
69	GND		68	Reserved	NC
71	Reserved	NC	70	Reserved	NC
73	Reserved	NC	72	+3.3V	
75	GND		74	+3.3V	

## A.2 COM Port

- 9-Pin Com Port Connector (COM1)

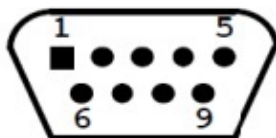

Pin	RS232	RS422	RS485
1	-		D-
2	RX	RX-	D+
3	TX	TX+	-
4	-	-	-
5	GND	GND	GND
6	-	RX+	-
7	RTS	TX-	-
8	CTS	-	-
9	-	-	-

- 9-Pin Com Port Connector (COM2/CAN)

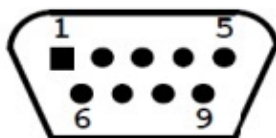

Pin	RS485	CAN
1	D-	-
2	D+	-
3	-	-
4	-	L
5	GND	-
6	-	-
7	-	-
8	-	GND (isolation)
9	-	H

CAN BUS  
Pin define



COM2  
Pin define

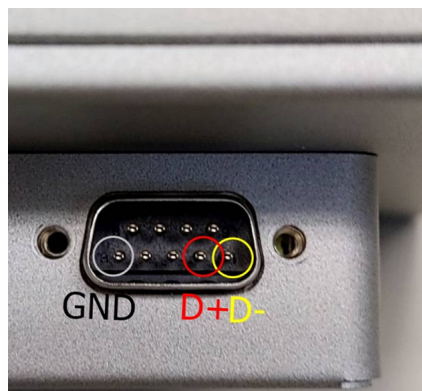

CAN BUS terminal (CN2)

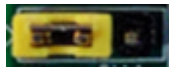
CN2 (1-2)	
CN2 (2-3) 120 ohm terminal default	

COM2 terminal (CN4)

CN4 (1-2) default	
CN4 (2-3) 120 ohm terminal	





## [www.advantech.com](http://www.advantech.com)

Please verify specifications before quoting. This guide is intended for reference purposes only.

All product specifications are subject to change without notice.

No part of this publication may be reproduced in any form or by any means, such as electronically, by photocopying, recording, or otherwise, without prior written permission from the publisher.

All brand and product names are trademarks or registered trademarks of their respective companies.

© Advantech Co., Ltd. 2023